

# AMVXMTG13/VXMTG13

13.3" Overhead LCD Monitor  
With Built-In DVD Player  
Owner's Manual

movies *to go*  
by VOXX

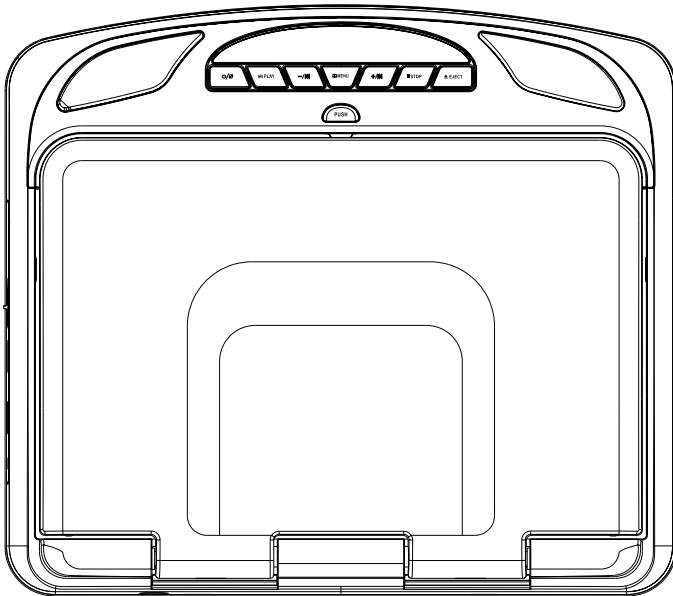



## Warnings

Do not use any solvents or cleaning materials when cleaning the video monitor.

Do not use any abrasive cleaners, they may scratch the screen.

Use only a lightly dampened lint free cloth to wipe the screen if it is dirty.

Lock the LCD screen in the fully closed position when not in use.

Before putting on headphones always adjust the volume setting to the lowest position.

Remember to leave the dome light switch in the off or auto positions when the vehicle is unattended, as the dome lights, if left on, can drain the vehicle's battery.

Do not put pressure on the screen.

Caution children to avoid touching or scratching the screen, as it may become dirty or damaged.

Patented: Refer to [www.voxxintl.com/patents](http://www.voxxintl.com/patents)



## Congratulations

Congratulations on the purchase of your new In-Vehicle Rear Seat Entertainment System. The AMVXMTG13/VXMTG13 has been designed to provide passengers with unlimited content options delivering smiles for many miles. Please read the directions that follow to familiarize yourself with the product to ensure that you obtain the best results from your equipment.

**Note:** Installation options vary, see the individual owner's manuals for each component in your system to obtain a full understanding of each component's operation.

## Safety Precaution

For safety reasons, when changing video media, it is recommended that the vehicle is not in motion, and that you do not allow children to unfasten seat belts to change video media or make any adjustments to the system. System adjustments can be accomplished using the remote control, while seat belts remain fastened. Enjoy your entertainment system but remember the safety of all passengers remains the number one priority.

## Table of Contents

Features .....	6
Controls and indicators diagram(front view) .....	7
Controls and indicators diagram(side view).....	9
Remote Control Operation .....	10
Remote Control Functions .....	11
Turning the unit on or off .....	15
Source menu .....	16
System Menu Setting and Adjustments .....	18
Playing DVD.....	25
DVD Basics .....	26
Playing USB and MP3 Discs.....	27
HDMI Basics .....	28
HDMI Devices.....	29
USB Input / Charging .....	30
Troubleshooting .....	31
Specifications.....	32
Warranty .....	33

## Features

- 13.3" Digital Thin Film Transistor (TFT) Active Matrix Liquid Crystal Display LED Backlight Monitor
- Built-in DVD Player
- Last position memory for DVD Player
- Five Audio / Video Source Inputs  
DVD, USB, AV, AUX, HDMI.
- USB 2.0 Port (User Accessible with Media Playback and Charging support)
- HDMI Input
- On Screen Display (OSD) for control of picture quality and functions
- Full function remote control
- Plays DVD, CD and MP3 discs
- 100 Channel Wireless FM Modulator
- Dual Channel IR Transmitter
- M1/M2 Operation (for when 2 systems are installed in 1 Vehicle so that IR Headphone Audio and Remote Control operation is independent)

## Controls and indicators diagram (front view)

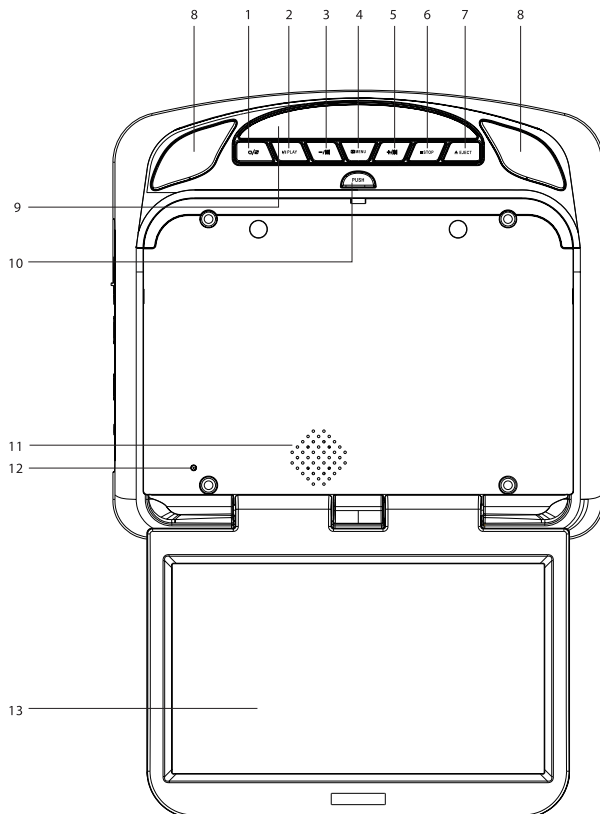

**1. POWER/SOURCE (⏻/🔄) Button**

This button is used to turn the system on/off and to select the source .

**2. Play/Pause (▶/⏸) Button**

This button is used to start playback of a disc or pause a disc.

**3. DOWN / Previous (◀/⏮) Button**

Short press to select the source mode and system menu pages.

Long press to select previous chapter or track during play the DVD.

**4. MENU Select Button**

This button is used to display and select options on the system menu.

**5. UP/NEXT(+/⏭) Button**

Short press to select the source mode and system menu pages.

Long press to select next chapter or track during play the DVD.

## Controls and indicators diagram (front view)-Continued

### 6. STOP (■) Button

-Press the STOP button once: Stops playback.

-Pressing the PLAY button again will resume normal playback from where movie was stopped.

-Press the STOP button twice and then press the PLAY button to start playback from the beginning of the DVD.

### 7. EJECT (▲) Button

This button is used for ejecting a disc from the disc compartment.

### 8. Dome Lights

Provides additional interior illumination.

### 9. Infrared Transmitter/Remote Sensor

*IR Transmitter:* is used to broadcast audio signal to wireless IR headphones.

*IR Sensor:* is used to receive signals from the remote control.

### 10. Screen Release

Push this button to release the screen from the locked position.

### 11. Ventilation Openings

### 12. LCD Off Switch

Used to turn off the LCD backlight when the LCD is in the closed position.

### 13. LCD Panel



## Controls and indicators diagram (side view)

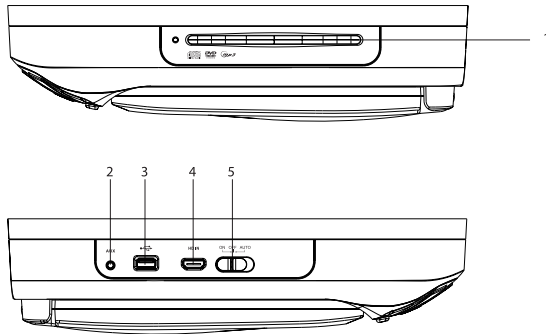

### 1. DVD Disc Insertion Slot

For loading and removing discs. When a disc is inserted, the unit will automatically turn ON and switch to DVD source. Insert a disc with label side facing up.

**Note:** The disc slot indicator is red when a disc is inserted and green when the disc slot is empty.

### 2. AUX IN

This jack is used to supply external audio and video inputs to the unit.

### 3. USB INPUT

For connection of a USB memory device. This input will also charge a USB device that contains a battery.

**Note:** The USB input supplies up to 2A of charging current. (Samsung Mobile Devices up to 500mA). It is recommended to connect the device to a vehicle power outlet for full charging capabilities.

### 4. HDMI INPUT

For connection of devices with HDMI outputs.

**Note:** Requires an HDMI enabled device and the appropriate adapter cable for that device. Contact your HDMI device supplier for the adapter.

### 5. THREE POSITION DOME LIGHT SWITCH

**ON** - Turns on the dome lights.

**OFF** - The dome lights will not turn on in this position.

**AUTO** - Automatically turns on the dome lights in conjunction with the vehicle's interior illumination.

## Remote Control Operation

### Battery Replacement

1. Remove the battery cover.
2. Insert two AAA batteries into the battery holder. Be sure to observe the correct polarity.
3. Reinstall the battery cover back into the Remote Control until it locks in place.

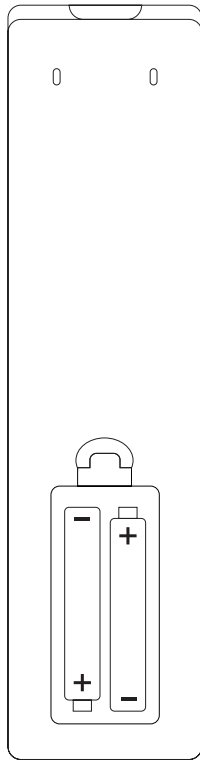
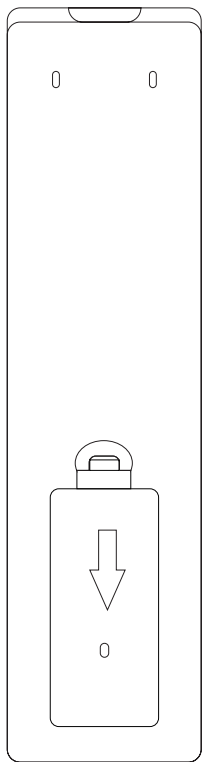

# Remote Control Functions

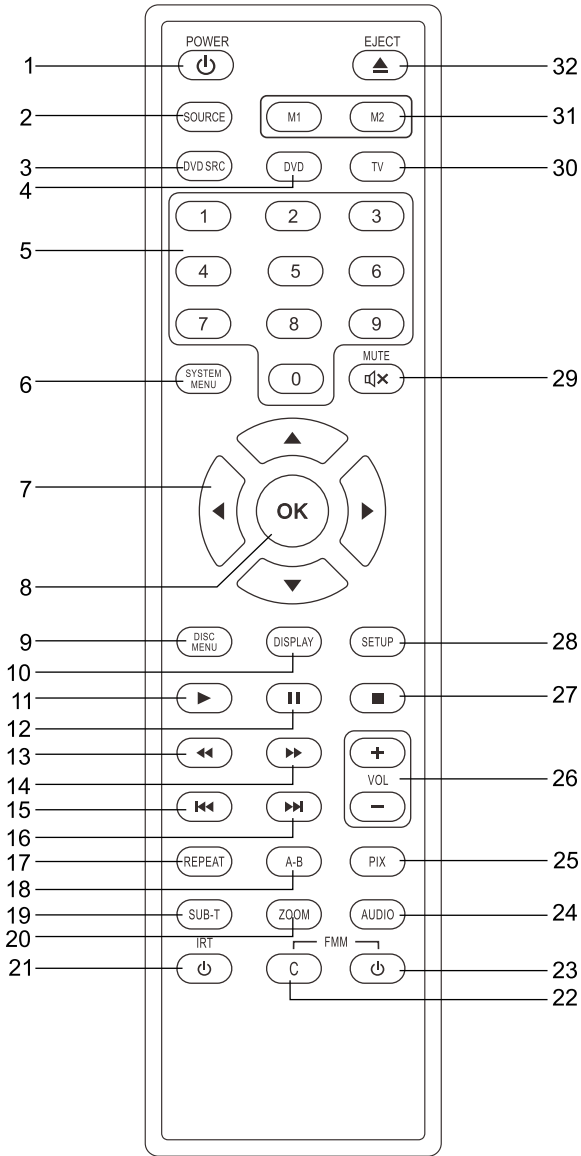

## Remote Control Functions(Continued)

\* Function control is available on the unit and the Remote Control.

\*\* Function not available in this model.

### 1. POWER\*

Press this button to turn the unit ON and OFF.

### 2. SOURCE\*

Press to display the Source OSD for DVD, USB, AV, AUX, HDMI.

### 3. DVD Source\*\*

No function on this model.

### 4. DVD Mode Select Button

Switches certain function keys on the remote control for DVD function.

### 5. NUMBERS

Allows the user to enter the numbers 0-9 for selection of the tracks, titles, chapters or password setting.

### 6. SYSTEM MENU

Allows the user to access the system menu. Press the ▲ or ▼ cursor buttons to select PICTURE, AUDIO, SYSTEM, PLAYER, FMM.

### 7. CURSOR (▲▼◀▶)

Use the cursor buttons to access menu selections on the screen.

### 8. OK

Used to execute a selected setting or menu option.

### 9. DISC MENU

In DVD mode, press once to access the Root Menu and then press again to resume to previous screen.

### 10. DISPLAY

Press once to display current disc information of Title, Chapter & Time. Press again to display Subtitle, Audio & Angle while the disc is playing.



### 11. PLAY (▶)\*

Press to activate the play mode while a disc is loaded into the disc compartment.

### 12. PAUSE (||)\*

Press to pause playback.

### 13. BACKWARD (◀◀)

Press to search in a backward direction. Press repeatedly to change the search speed from 2, 4, 8, 20 times and normal speed.

## Remote Control Functions(Continued)

### 14. SCAN FORWARD (▶▶)

Press to search in a forward direction. Press repeatedly to change the search speed from 2, 4, 8, 20 times and normal speed.

### 15. PREVIOUS (◀◀)

Press to return to the previous chapter or track.

### 16. NEXT (▶▶)

Press to skip to the next chapter or track.

### 17. REPEAT

Allows the user to repeat a selected chapter, title or all track.

### 18. A-B REPEAT

Allows user to repeat the playback from point A to point B.

Press A-B button

On-Screen Display

DVD player

Once

Repeat A

Mark the beginning of the section to repeat (Set point A)

Twice

A-B

Mark the end of the section to repeat (Set point B)

3 times

AB Off

Cancel the A-B repeat function

### 19. SUBTITLE

Press to display and select the subtitle language in DVD mode. Each time this button is pressed, the subtitle language changes. Pressing the button will also turn the subtitles off.

**Note:** The type and number of subtitle languages vary from disc to disc.

### 20. ZOOM

Press this button to enlarge or decrease the picture size when playing a DVD disc.

**Press ZOOM button**

**DVD Player performs**

1 Time

Enlarges the picture 2X

2 Times

Enlarges the picture 3X

3 Times

Enlarges the picture 4X

4 Times

Reduces the picture 1/2

5 Times

Reduces the picture 1/3

6 Times

Reduces the picture 1/4

7 Times

Picture is returned to original size

### 21. IRT ON/OFF

Turns the Infrared Transmitter on/off for IR wireless headphones.

### 22. FM MODULATOR CHANNEL SELECT (C)\*\*

No function on this model.

User may use the system menu to select the FM Modulator.

### 23. FMM ON/OFF

Turns the FM Modulator power on/off.

## Remote Control Functions(Continued)

### 24. AUDIO

Press to display and select audio language in DVD mode. Each time this button is pressed, the language changes.

### 25. PIX ( Picture Select )

This button is used to make picture adjustments. Use the UP or DOWN direction buttons to select BRIGHTNESS, CONTRAST,COLOR, TINT, or RESET. Use the UP or DOWN buttons to adjust the setting. The OSD will automatically disappear if no adjustments are made within 6 seconds.

### 26. VOLUME DOWN (-) or UP (+)\*\*

No function on this model.

### 27. STOP (■)\*

Press to stop playback. (Playback will resume from the point it is stopped).

Press twice to stop playback fully. (Playback will resume from the beginning of the disc).

**Note:** For MP3 or photo mode, press twice to return to Audio/Photo/Video option menu.

### 28. SETUP\*\*

No function on this model.

User can use the system to select the function may need.

### 29. MUTE

Press this button to mute the audio for the wireless FM Modulator, IR headphones and audio output.

Pressing the button again restores the audio to the previously set level.

### 30. TV Mode Select

Switches certain function keys on the remote control for monitor functions.

### 31. MONITOR SELECT

**M1 Button** – Set the remote control code to allow control of the unit in M1 mode.

**M2 Button** – Set the remote control code to allow control of the unit in M2 mode.

**Note: M1/M2 operation is only for when 2 systems are installed in the same vehicle.**

**This allows independent Remote Control and independent playback of audio for each system..**

### 32. EJECT (▲)\*



Press this button to eject the disc.

## Turning the unit on or off

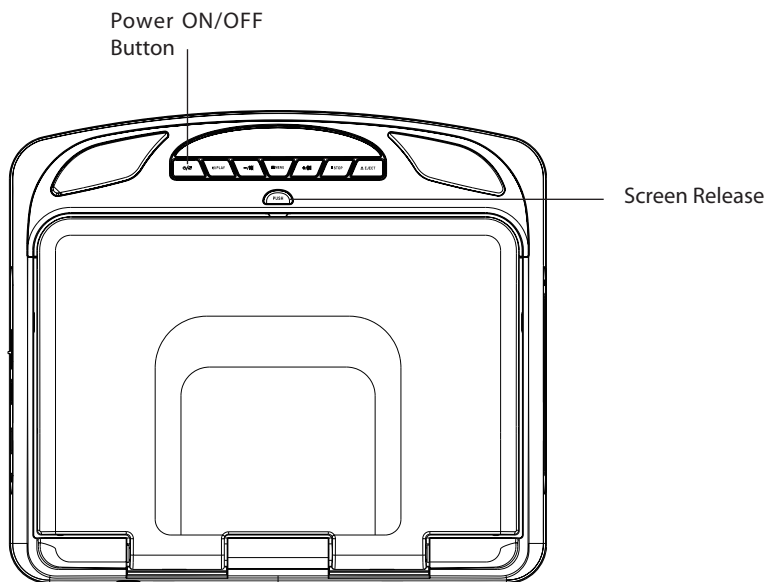
1. Push in the Screen Release button to unlock the LCD screen. The screen will drop down slightly.
2. Pivot the screen downward until a comfortable viewing angle is reached. The hinge friction will hold the screen in position while the system is in use.
3. Press the power button on the unit or the remote control to turn the system on and off. When in use, the internal backlighting will illuminate the controls.
4. After the unit has been turned on and is displaying a picture, adjust the viewing angle by pivoting the screen to optimize the picture quality.
5. Remember to turn the unit off and pivot the LCD screen to the locked position when not in use.



## Source Menu

The System is capable of accessing six source inputs. To select or change a source, press the source  button on the front panel or the Source button on the remote control. The source OSD will appear on the screen as shown in the figure below. Use the + or - cursor buttons on the front panel or the ▲ or ▼ cursor buttons on the remote control to highlight a source. Press the Source  button on the front panel or the **OK** button on the remote control to select the desired source.

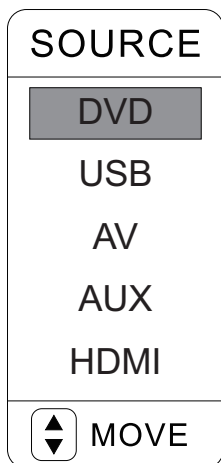

### DVD

The DVD source input is used to play DVDs, Audio CDs and MP3 discs.

### USB

The USB source input is used to play MP3 files, JPEG files (Photos) and MPEG I, II files.

### AV

An external video source such as a video game system, or other audio/video devices can be connected to the AV input. This AV input connection is performed when the unit is installed. Turn the video source component on with its power button or remote control and it is now ready to play the audio and video signals from the source connected to the AV input.

### AUX

An external video source such as a video game system or other audio/video devices may be connected to the system via the AUX input. Connect your peripheral device to the supplied Aux Adapter harness and plug the harness into the AUX Input on the side of the system. Turn the external source component on with its power button or remote control and it is now ready to play the audio and video signal from the source connected to AUX.



## Source Menu(Continued)

### HDMI

This Source input allows the user to enjoy high-definition digital images and high-quality sound by connecting an HDMI device such as a smartphone, tablet or SmartTV Streaming devices with an HDMI output to the system. Connect your HDMI device with an optional HDMI cable. Smartphones and Tablet require the appropriate adapter for your smart device. You can also use this input to connect a SmartTV Stick such as a ROKU, Amazon FireTV or Chromecast device (these devices may require Wi-Fi Hotspot access to stream content which is not included with this system).

### Notes:

- This source requires an HDMI enabled device and a special HDMI adapter. Contact your HDMI device supplier for the adapter.
- Phone functionality (phone calls, texting, etc.) may be limited while using the adapter.
- HDMI content is copy protected and is not available on the AV output of the System.

## System Menu Setting and Adjustments

The Setup Menu contains features and options that let you customize your DVD player. For example, you can set a language for the on-screen display or set up PARENTAL controls to control DVD playback for children.

### Using the System Menu

1. Press the System Menu button on the remote. The System Menu appears on the screen as shown in the figure below. There are 6 icons that will appear individually in the upper left hand corner of the System Menu as each option is selected.

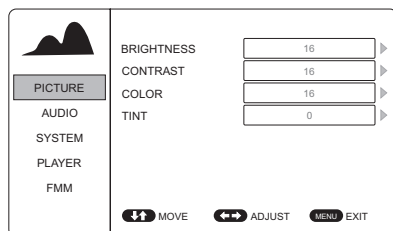

2. To select the desired setup option, move the highlighted (in blue) option using the up/down (▲▼) cursor buttons. Press the right (▶) cursor button to access the options on the right hand side of the screen.
3. After entering the setup area (on the right side of the screen), highlight the desired option using the up/down (▲▼) cursor buttons.
4. Press the right (▶) cursor button to toggle the sub menu that contains the different options available.
5. Repeat steps 3 and 4 to set the options for each option on the same Setup Page.
6. To change to another Setup page, press the system menu cursor button to the icon side of the setup page. Then, repeat steps 2 through 5.

## System Menu Setting and Adjustments(Continued)

7. If without a Remote control user can use the local key to select the function setting.
- a.) Menu = Long press to call up the setup menu screen information or return/exit the system menu  
= Short press function as Down Key
  - b.) ►/|| Play = Enter Key
  - c.) -/◀ = Left Key
  - d.) +/▶ = Right Key

### PICTURE CONTROL

The PICTURE setup functions allows the user to select and set the picture control function.

BRIGHTNESS, CONTRAST, COLOR adjustments range from 0 to 32.

TINT adjustments range from -16 to 16.

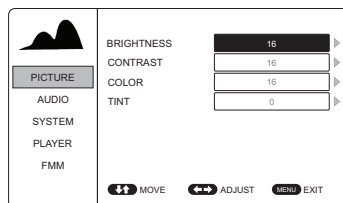

### AUDIO MODE

The AUDIO setup functions allows the user to select and set the IRT Headpone transmitter "CHA" or "OFF".

### IRT

The IR transmitter can be set to CHA or OFF. The IR Transmitter must be set to "CHA" for the wireless headphone to be operational.

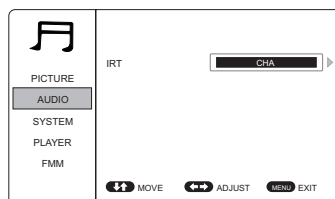

## System Menu Setting and Adjustments(Continued)

### SYSTEM MODE

The system setup function allow the user to select the system function. Functions listed below.

### LANGUAGE

The LANGUAGE setup allows the user to select ENGLISH, CHINESE, SPANISH, FRENCH and JAPANESE for the on-screen language display.

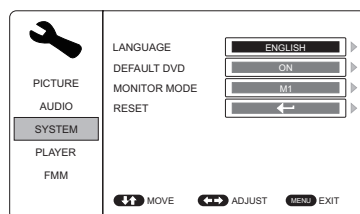

### DEFAULT DVD

The DEFAULT DVD allows the user to set the system default source to DVD ON or OFF.

If source default is set to ON, every time the unit is turned off the on, the unit will power up and automatically switch the source to DVD.

If source default is set to OFF and the system is turned off then on, the unit will power up in the source that was last selected.

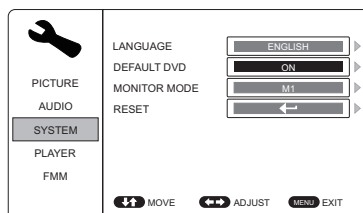

### MONITOR MODE

This allows the user to change the system to M1 or M2 mode. Once the setting is changed, the remote control and IR headphones will only work if set to that same setting.

1. M1 Mode - For the Remote Control to operate the system when set to M1, press the M1 button on the Remote Control.  
Please make sure IR Headphones are set to Channel A when the system is in M1 mode.
2. M2 Mode - For the Remote Control to operate the system when set to M2, press the M2 button on the Remote Control.  
Please make sure IR Headphones are set to Channel B when the system is in M2 mode.

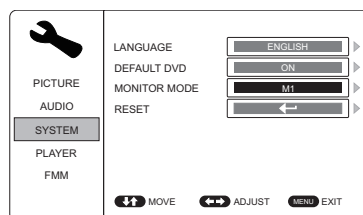

## System Menu Setting and Adjustments(Continued)

### RESET

The RESET functions allows all settings options to be reset to factory settings.

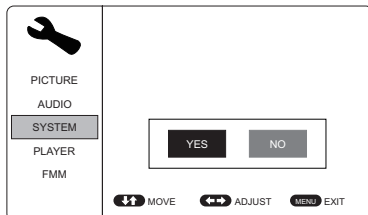
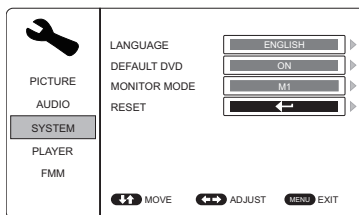

### PLAYER MODE

The Player setup function allow the user to select DVD functionality.

### TV SYSTEM

The TV SYSTEM setup allows the user to choose television standard which corresponds to your TV.

NTSC-Select this type for NTSC TV

PAL-Select this type for PAL TV

AUTO-Select this type if the connected screen is a multi-system TV. The video format of the disc (NTSC or PAL) will determine the video signal output.

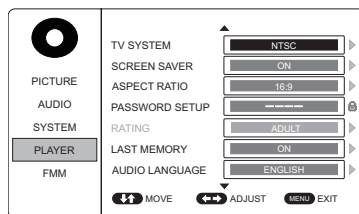

### SCREEN SAVER

This allows you to set the Screen Saver mode.

ON -Screen Saver will appear

OFF -Screen Saver will not appear

**Note:** The DVD player will enter Screen Saver mode if the unit is inactive for approximately 2 minutes.

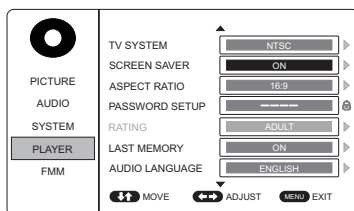

## System Menu Setting and Adjustments(Continued)

### ASPECT RATIO(For DVD Screen Display)

#### 4:3 PS (Pan Scan)

The left and right of the screen are cut off and displays the central portion of the 16:9 screen.

#### 4:3 LB (Letter Box)

Displays the content of the DVD title in the 16:9 aspect ratio.The black bars will appear at the top and bottom of the screen.

#### 16:9

This displays a wide picture with black bands on the upper and lower portion of the screen. The bandwidth will vary,depending on the aspect ratio of the disc.

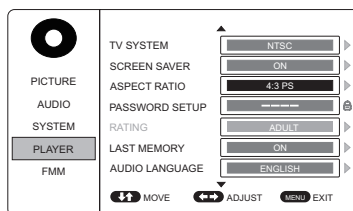

### PASSWORD SETUP

The default password is 3308. To change the rating of the DVD player press 3308 to access the RATING setting.

**NOTE:** 3308 must be pressed to set a new password.

- Press 3308
- Enter the new 4 digit password
- Press SETUP 2 times to exit the setup mode.

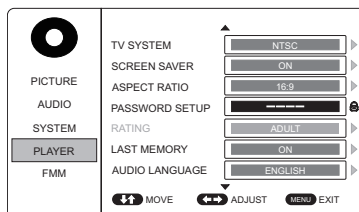

**NOTE:** The 3308 password is always accepted in the setup menu even after a new password has been entered. To avoid the possibility of others using the default password to set the parental level and change the password, record this default password in another area and delete it from this manual. The restriction of viewing disc content by younger users may be available on some discs, but not on others.

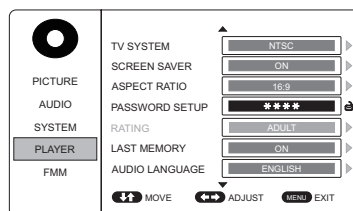

**NOTE:** When the password is set to a new password, that password must be used to play movies that have content rated above the setting in the setup menu. The user will be prompted to put the password in before the movie can play. After the password is entered press the OK button on the remote control.

## System Menu Setting and Adjustments(Continued)

### LAST MEMORY

The last memory function allows DVD playback to begin from the point when playback was last stopped. The last memory feature allows the user to turn the last memory feature function on or off.

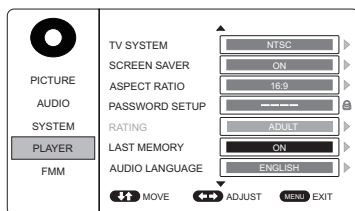

### AUDIO LANGUAGE

This setting allows you to select a preferred audio language. This function only applies to discs encoded with different audio languages. Options: ENGLISH, CHINESE, SPANISH, FRENCH, and JAPANESE.

**NOTE:** If the selected language is not available for the currently playing disc, the disc's default setting is applied.

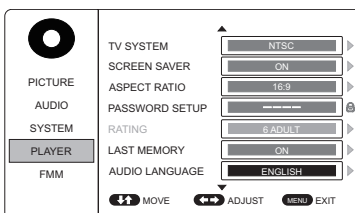

### SUBTITLE LANGUAGE

This setting allows you to select a preferred subtitle language. This function only applies to discs encoded with subtitles. Options: ENGLISH, CHINESE, SPANISH, FRENCH and JAPANESE

**NOTE:** If the selected language is not available for the currently playing disc, the disc's default setting is applied.

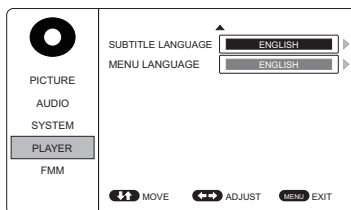

### MENU LANGUAGE

This setting allows you to select a preferred disc menu language. Options: ENGLISH, CHINESE, SPANISH, FRENCH, and JAPANESE

**NOTE:** If the selected language is not available for the currently playing disc, the disc's default setting is applied.

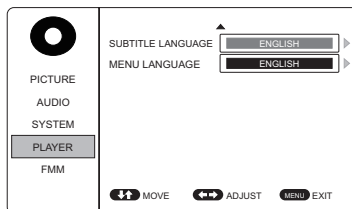

## System Menu Setting and Adjustments(Continued)

### FMM MODULATION(ON/OFF)

This setting allows you to turn the FMM modulator ON or OFF.

### FMM CHANNEL

This setting allows you to select the frequency. The unit has a 100 channel built-in wireless FM Modulator. The FM Modulator can be set from 88.1MHz to 107.9MHz in 0.2MHz steps, i.e.88.1,88.3,88.5,88.9,90.1 etc.

### To choose an FM frequency for audio playback through your vehicle's radio:

1. Use the ▲ ▼ ◀ ▶ or cursor buttons to select a frequency not used by a radio station in the area. Press OK to select the highlighted frequency. There are a total of 3 FM CHANNEL pages containing frequencies from 88.1 MHz to 107.9 MHz in 0.2 MHz steps. To access the additional FM Channel pages, use the ◀ or ▶ cursor buttons to highlight the on screen left and right arrows and press OK. Once the frequency has been selected, tune the vehicle's radio to the selected frequency.
2. Press the DVD button to restore the remote control to DVD functions.

**Note:** The wireless FM modulator will perform well in most applications. However, in certain geographical areas the quality of the wireless signal may be less than optimal, resulting in static or strong local station bleed through. If this is a consistent problem, an FMDIRB (hard wired FM connection) can be installed by your dealer.

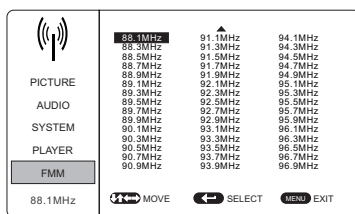
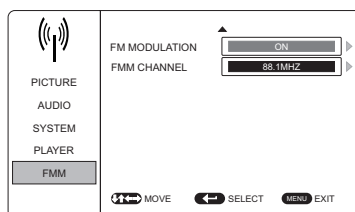
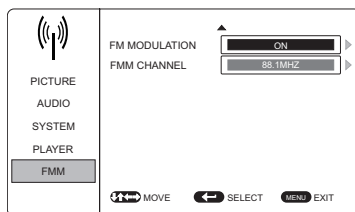



## Playing DVD

### Playing DVDs

When a disc is loaded. Press the DISPLAY button on the remote control to display the status banner. The status banner includes the disc title, chapter audio language , subtitle & angle.

Title Selection: Some DVDs contain more than one title (e.g. sitcoms, collections, etc.) Press the numeric (0-9) buttons to initiate a change of chapter title selection. Using the repeat feature to select OFF, Chapter, Title and Repeat All to play the movies contents.

### Playing Audio CDs

When playing an audio CD, the DISPLAY banner appears automatically. The track number and the elapsed time of the disc are displayed.

Selecting a Track: Selection of a specific track is accomplished by using the numbers keys. Press the number key corresponding to the desired track and the player will implement the selection.

- Press the previous button (⏮) to return to the previous chapter or track.
- Press the next button (⏭) to skip to the next chapter or track.

### Using the REPEAT feature

The default mode for the Repeat feature is OFF. Pressing REPEAT on the remote control consecutively changes the repeat options.

- OFF                Plays all songs on the disc and stops after all songs are played
- REP 1             Repeats 1 song
- REP DIR          Plays songs in the directory
- REP ALL          Plays all songs on the disc repeatedly

## DVD Basics

To get the optimum use out of the DVD Player, please read the following:

### DVD Region Code

The DVD player is preset to a region code at the factory depending on where the DVD player is sold. A DVD from a different region cannot be played in this unit and the unit will display "WRONG REGION".

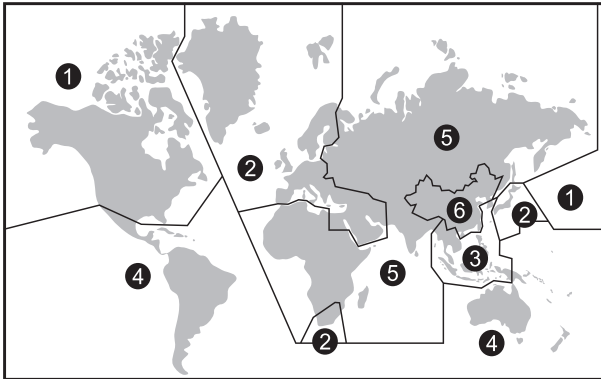

*Region 1* - USA, Canada

*Region 2* - Japan, Europe, South Africa, Middle East, Greenland

*Region 3* - S. Korea, Taiwan, Hong Kong, Parts of South East Asia

*Region 4* - Australia, New Zealand, Latin America (including Mexico)

*Region 5* - Eastern Europe, Russia, India, Africa

*Region 6* - China

### Playing USB Devices

To play a USB device, change the source to USB and plug a USB device into the USB port. When a USB device is inserted into the player the navigation menu appears automatically.

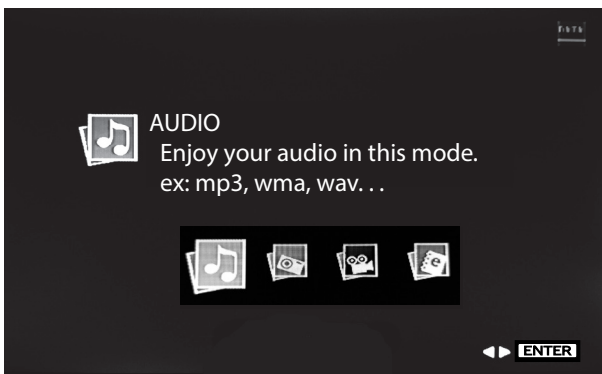

## Playing USB and MP3 Discs

Use the cursor keys ▲ ▼ ◀ or ▶ and OK to navigate the on screen menus.

The USB port can play AUDIO, PHOTO, VIDEO . The following formats are supported:

### Audio

- MP3
- WMA
- AAC

### Photo

- JPEG
- BMP

### Video\*

- AVI (MPEG4-DIVX (DIVX 4.0/5.0), MPEG4-XVID - (720 x 576 max resolution)
- MPG (MPEG-1) - (720 x 576 max resolution)
- MOV (MPEG4-DIVX) - (720 x 576 max resolution)
- FLV (FLV1) - (720 x 576 max resolution)
- SWF (FLV1) - (720 x 576 max resolution)
- DAT (MPEG1) - (720 x 576 max resolution)
- VOB (MPEG2) - (720 x 576 max resolution)

Note: All formats may not play depending on the software used to convert the video file from its original format.

## Playing MP3 Discs

### Playing MP3 Discs

MP3 is a format for storing digital audio. An audio CD-quality song can be compressed into MP3 format with very little loss of quality, while taking up much less space. CD-R discs that have MP3 format files can be played on the DVD player. The DVD player plays the songs in the order they were burned on to the disc.

Selecting Folders and Songs:

When an MP3 disc is loaded in the player, the navigation menu will appear on the screen automatically and a song will start playing.

To change songs use the ▲ ▼ arrows to select a different song and press the OK or ► button to play the selected song. To change folders press the ▲ button to move to the root folder and press the OK or ► button to display all the folders on the disc. Use ▲ ▼ the buttons to select a new folder and press the OK or ► button to enter the new folder. The unit will begin playing the first song of the folder.

## HDMI Basics

### HDMI

An HDMI Input is located on the side of the unit.

This input can be used for connecting devices with HDMI output ports (such as smartphones, tablets and SmartTV devices) and may require the purchase of an HDMI cable and HDMI adapter which is available from your device manufacturer. Each device has unique requirements, please consult with your device or smartphone manufacturer to determine which type of output your device supports.

**NOTE:** Some smartphone HDMI adapters and SmartTV Sticks can be powered from the USB port on the side of the unit . Powering the adapter will charge the smartphone or supply power to the SmartTV Stick when using these devices as a media source.

### Smartphones and Tablets

For Apple products, go to the Apple Store or enter the following link into your web browser to find the adapter required for your device. Different models require different adapters.

• <http://support.apple.com/kb/ht4108> \*



See the following links for other smartphone and tablet manufacturers:

Samsung Multimedia adapter:

• <http://www.samsung.com/us/mobile/cell-phones-accessories/multimedia-adapters>



**NOTE:** Some Samsung smartphones may require an additional 5-pin micro USB to 11-pin micro USB adapter in addition to the multimedia adapter.

For other smartphone makes and models check with your device service provider to find an adapter that will work with your device.

Amazon is a good source for finding an adapter that will work with your smartphone.

## HDMI Devices

### HDMI Devices \*\*:

Amazon FireTV Stick streaming device:

- [www.amazon.com](http://www.amazon.com) and search for FireTV Stick



Chromecast media streaming device:

- [www.google.com](http://www.google.com) and search for Chromecast



Roku HDMI streaming device:

- <http://www.roku.com/products/compare>



## USB Inputs/ Charging

### USB Port (User Accessible)

The USB port provides two functions:

1. Media port for USB thumb drives:
2. Charging:
  - The USB port will not charge a portable device when the unit is turned OFF.
  - The USB port will charge a portable device in the following modes:
    - DVD/USB (Not recommended)
    - AV
    - AUX
    - HDMI
  - It will not charge in USB mode.
  - For Apple /Android Mobile , It will charge at up to 2 Amps of charging current.
  - For Samsung Mobile, It will charge at up to 500mA of charging current.

## Troubleshooting

PROBLEM	SOLUTION
IR remote inoperative	<ul style="list-style-type: none"> <li>• Verify that the battery in the remote is fresh.</li> <li>• Verify that the remote sensor eye is not obstructed.</li> </ul>
Disc won't play	<ul style="list-style-type: none"> <li>• Insert a disc with the label side facing the viewer.</li> <li>• Check the type of disc you put into disc tray. This DVD only plays DVD, audio CD and MP3s.</li> <li>• Both the unit and the disc are coded by region. If the regional codes don't match, the disc can't be played.</li> </ul>
Play starts, but then stops immediately	<ul style="list-style-type: none"> <li>• The disc is dirty. Clean it.</li> <li>• Condensation has formed. Allow player to dry out.</li> </ul>
No sound or distorted sound	<ul style="list-style-type: none"> <li>• Make sure your DVD is connected properly. Make sure all cables are securely inserted into the appropriate jacks.</li> <li>• If you are using the 2-channel IR headphones, make sure you turn on the IR headphone power, make sure the correct channel (A or B) is selected.</li> <li>• If the FM Modulator is ON make sure proper frequency has been selected.</li> </ul>
Cannot advance through a movie	<ul style="list-style-type: none"> <li>• Most discs prohibit advancing through the opening credits and warning information that appear at the beginning of movies.</li> </ul>
The icon (⓪) appears	<ul style="list-style-type: none"> <li>• The feature or action cannot be completed at this time because:               <ol style="list-style-type: none"> <li>1. The disc's software restricts it.</li> <li>2. The disc's software doesn't support the feature (e.g., angles)</li> <li>3. The feature is not available at the moment.</li> <li>4. A title or chapter number that is out of range has been requested.</li> </ol> </li> </ul>
Picture is distorted	<ul style="list-style-type: none"> <li>• The disc might be damaged. Try another disc.</li> <li>• It is normal for some distortion to appear during forward or reverse scan.</li> </ul>

## Specifications

### AMVXMTG13/VXMTG13

Type	TFT Active Matrix LCD
Resolution	1920 (RGB) (X3) x 1080
Pixels	6,220,800
Operation Temperature	32 ~ 113° F (0 ~ 45° C)
Storage Temperature	-4 ~ 149° F (-10 ~ 65° C)
Backlit life	20,000 Hours
Video Display System	NTSC / PAL / AUTO
Video Output	1.0Vp-p @ 75 ohms
Power Source	12VDC
Dimension (L x W x H)	375mm x 330mm x 82.9mm 14.8in x 13.0in x 3.3in

Specifications subject to change without notice.





## 12 MONTH LIMITED WARRANTY

*Applies to Movies To Go Mobile Video Products*

VOXX ELECTRONICS CORP. (the Company) warrants to the original retail purchaser of this product that should this product or any part thereof, under normal use and conditions, be proven defective in material or workmanship within 12 months from the date of original purchase, such defect(s) will be repaired or replaced with reconditioned product (at the Company's option) without charge for parts and repair labor. A game controller, if supplied, is similarly warranted for ninety (90) days.

To obtain repair or replacement within the terms of this Warranty, the product is to be delivered with proof of warranty coverage (e.g. dated bill of sale), specification of defect(s), transportation prepaid, to the Company at the address shown below.

This Warranty does not extend to the elimination of externally generated static or noise, to correction of antenna problems, to costs incurred for installation, removal or reinstallation of the product, or to damage to digital memory/media devices, gaming devices, discs, speakers, accessories, or vehicle electrical systems.

This Warranty does not apply to any product or part thereof which, in the opinion of the Company, has suffered or been damaged through alteration, improper installation, mishandling, misuse, neglect, accident, or by removal or defacement of the factory serial number/bar code label(s). THE EXTENT OF THE COMPANY'S LIABILITY UNDER THIS WARRANTY IS LIMITED TO THE REPAIR OR REPLACEMENT PROVIDED ABOVE AND, IN NO EVENT, SHALL THE COMPANY'S LIABILITY EXCEED THE PURCHASE PRICE PAID BY PURCHASER FOR THE PRODUCT.

This Warranty is in lieu of all other express warranties or liabilities. ANY IMPLIED WARRANTIES, INCLUDING ANY IMPLIED WARRANTY OF MERCHANTABILITY, SHALL BE LIMITED TO THE DURATION OF THIS WRITTEN WARRANTY. ANY ACTION FOR BREACH OF ANY WARRANTY HEREUNDER INCLUDING ANY IMPLIED WARRANTY OF MERCHANTABILITY MUST BE BROUGHT WITHIN A PERIOD OF 24 MONTHS FROM DATE OF ORIGINAL PURCHASE. IN NO CASE SHALL THE COMPANY BE LIABLE FOR ANY CONSEQUENTIAL OR INCIDENTAL DAMAGES FOR BREACH OF THIS OR ANY OTHER WARRANTY. No person or representative is authorized to assume for the Company any liability other than expressed herein in connection with the sale of this product.

VOXX Electronics Corporation,  
2351 J. Lawson Blvd, Orlando FL 32824 | 1-800-645-4994







For Customer Service  
Visit Our Website At  
**[www.voxxelectronics.com](http://www.voxxelectronics.com)**  
Product Information, Photos,  
FAQ's, Owner's Manuals