

homebase™

DPF710K

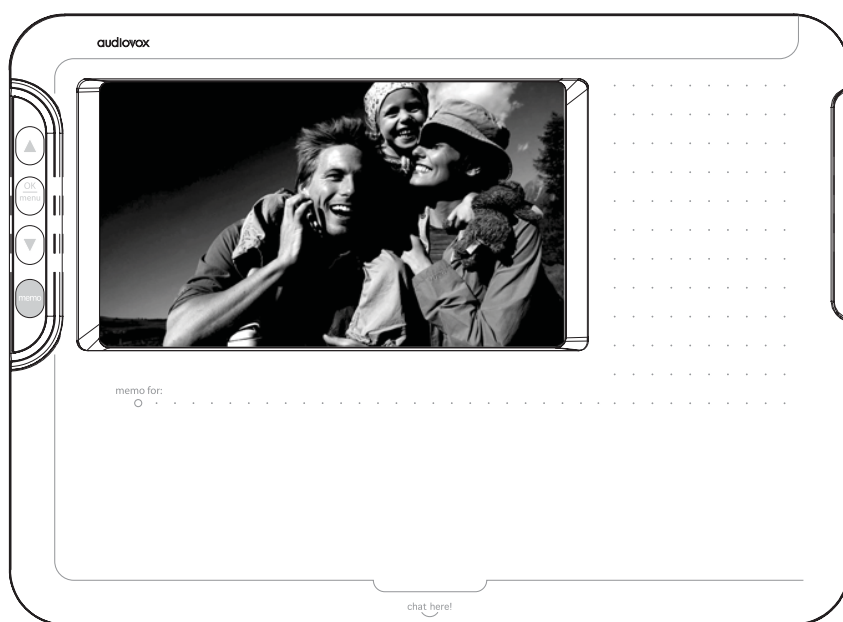

audiovox

Table of Contents

Important Safety Instructions	3
Introduction	4
Product Features	5
What's in the Box?	6
Installation	7
homebase Refrigerator Installation	7
homebase Countertop Installation	8
homebase Wall Mount Installation Using the Wall Mount Bracket	9
homebase Wall Mount Installation Using the Angle Mount Brackets	10
Internal Battery Activation and/or Replacement	11
Controls, Indicators and Connectors	12
Accessory Placement	13
Operating the Homebase	14
Preliminary Connections	14
Connecting the Power	14
Inserting the Memory Card/USB Device	14
Power On/Main Menu	15
Preliminary Checks	15
Power On/Main Menu	15
Memo Feature	16
Calendar Memos	17
Recording Calendar Memos	17
Reviewing Calendar Memos	18
Countdown Timer	19
Photo Menu	20
Photo Library Menu	21
External Media Menu	22
Settings	23
1. General Setup - Photo Mode Selection	23
2. General Setup - Time/Date Setting	24
3. General Setup - Alarm Setting	25
4. General Setup - Clock Display	26
Technical Data	27
Warranty	28

Important Safety Instructions

Please read all safety and operating instructions carefully before installation, and keep these instructions handy for future reference. Take special note of all warnings listed in these instructions and on the unit.

1. **Water and Moisture:** The unit should not be used near water. For example: near a bathtub, swimming pool, etc.
2. **Ventilation:** The unit should be situated so that its location or position does not interfere with its proper ventilation.
3. **Heat:** The unit should be situated away from heat sources such as radiators, heat registers, stoves, or other appliances (including amplifiers) that produce heat.
4. **Power Source:** The unit should be connected to a power supply only of the type described in the operating instructions or as marked on the appliance.
5. **Power Cord Protection:** Power cords should be routed so that they are not likely to be walked on or pinched by items placed up or against them. It always best to have a clear area from where the cord exits the unit to where it is plugged into an AC outlet.
6. **Cleaning:** The unit should be cleaned as needed with a soft, non-abrasive cloth.
7. **Object and Liquid Entry:** Care should be taken so that objects do not fall and liquids are not spilled into any openings or vents located on the product.
8. **Attachments:** Do not use attachments not recommended by the product manufacturer.
9. **Lightning and Power Surge Protection:** Disconnect the unit from AC power during any electrical storm in the immediate vicinity. This will prevent damage to the product due to lightning and power-line surges.
10. **Overloading:** Do not overload wall outlets, extension cords, or integral convenience receptacles as this can result in a risk of fire or electric shock.
11. **Damage Requiring Service:** This unit should be serviced by qualified service personnel when:
 - a. The power supply cord or plug has been damaged.
 - b. Objects have fallen into or liquid has been spilled in the product enclosure.
 - c. The unit has been exposed to rain.
 - d. The unit has been dropped or the enclosure damaged.
 - e. The unit exhibits a marked change in performance or does not operate normally.
12. **Servicing:** The user should not attempt to service the unit beyond those methods described in the User's Manual. Service methods not covered in the operating instructions should be referred to qualified service personnel.

homebase™

Introduction

Your homebase allows you to:

- Display your digital photos from its internal memory, a memory card, or USB memory devices
- Record and retrieve audio messages
- Use the calendar to set audio and/or event reminders
- Display time and date
- Use a timer, set an alarm
- Leave a written message on the front of the unit or the Post-it® pad.

Product Features

Overall Description :

- 7-inch color LCD displays photos, calendar and clock
- 512 MB of memory-enough for more than 100 pictures depending on image size
- Internal microphone for recording digital voice messages
- Internal speakers with volume control
- Magnetic border for posting notes, coupons, etc.
- LED indicator lights when there's a message
- Erasable white board and dry erase marker for quick notes and messages
- Post-it® notes for lists and reminders
- 3-key navigation for simple operation
- Multiple mounting options: refrigerator, wall and countertop.
- Supports SD/MMC, MS, xD, and CF memory cards and USB flash drives
- Interactive Calendar and Digital Clock
- Digital clock with alarm
- Countdown timer

homebase™

What's in the Box?

homebase

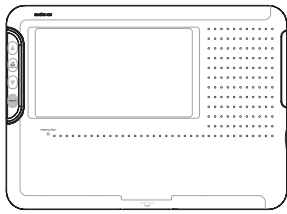

Wall Mount Bracket (1)

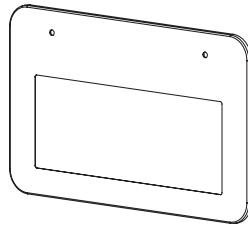

Angle Mount Bracket (2)

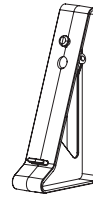

AC to DC Power Adapter (1)

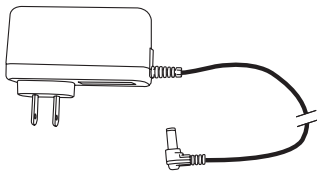

Post-It® Note Pad (1)

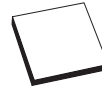

Button Magnet (2)

Adhesive Foam Pad (2)

Wire Management System (3)
(Black, White, Clear)

Dry Erase Marker (1)



Plastic Wall Anchor (2)



Flat-Head Self-Tapping
Screw (2)



Double-Sided Tape (1)

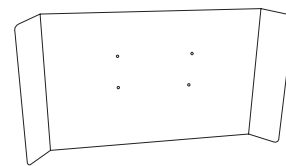

Mounting Hole Template (1)

Installation

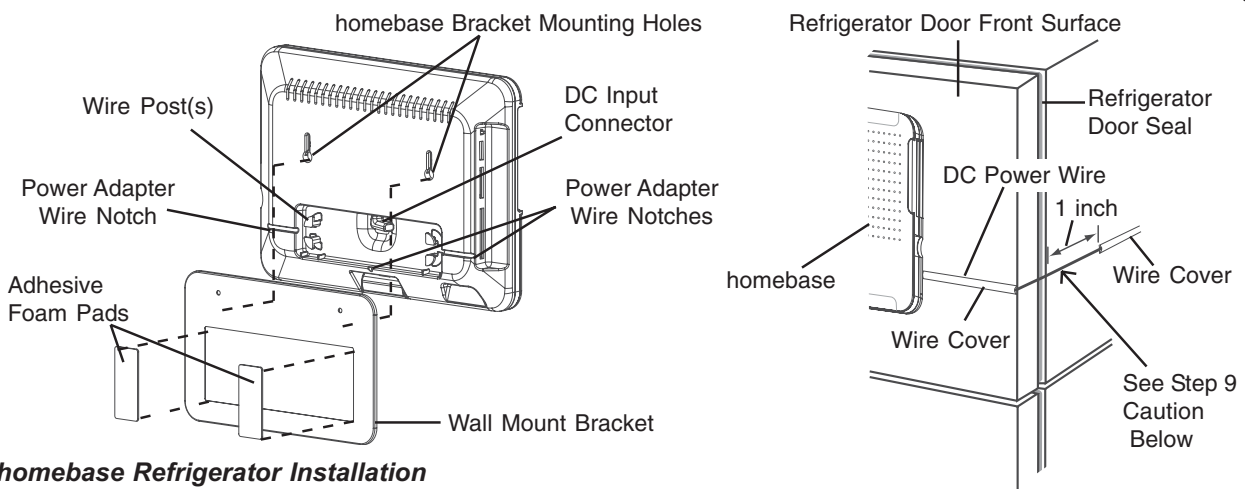

homebase Refrigerator Installation

1. Remove the protective backing from one side only of the two adhesive pads and position them on the back of the wall mount bracket as shown.
2. Clean the homebase mounting area on the refrigerator with isopropyl alcohol; **do not use a glass cleaner**.
3. Place the wall mount bracket in the desired area and level the top of the bracket.

Note: Before removing the remaining protective backing from the two adhesive pads, be sure of the homebase mounting location as **the adhesive pads are not designed to be removed and repositioned** once they are applied to the refrigerator surface.
4. Remove the protective backing from the two adhesive pads, line up the top of the bracket, and firmly press and hold the bracket in place on the refrigerator surface to ensure the pads adhere securely.

Note: 3M™ recommends waiting 24 hours for maximum adhesion prior to mounting your homebase to the mounting bracket.
5. Connect the power adapter plug to the **DC** input connector at the rear of the homebase.
6. Choose the direction of the adapter wire in reference to the AC wall outlet. Place the DC wire in the corresponding wire notch.
7. Check the amount of wire required to reach the AC outlet. Spool excess wire on the four posts inside the rear cavity of the homebase.
8. Attach the homebase to the bracket by lining up the homebase bracket mounting holes with the wall bracket mounting tabs, and slide the homebase down until the mounting tabs engage the mounting hole slots.
9. Cover the power adapter wire with the clear, black or white wire cover; seal the cover using the double-sided tape and dress the wire, adhering it to the refrigerator surface.

Caution: The power adapter wire routing follows the right angle contour of the refrigerator door. Do **NOT** cover the DC power adapter wire using the double-sided tape after the 90 degree transition from the front refrigerator surface to the side surface and for at least one inch rearward of the refrigerator seal. This will allow movement of the power adapter wire as the refrigerator door opens and closes.

homebase™

Installation (Cont)

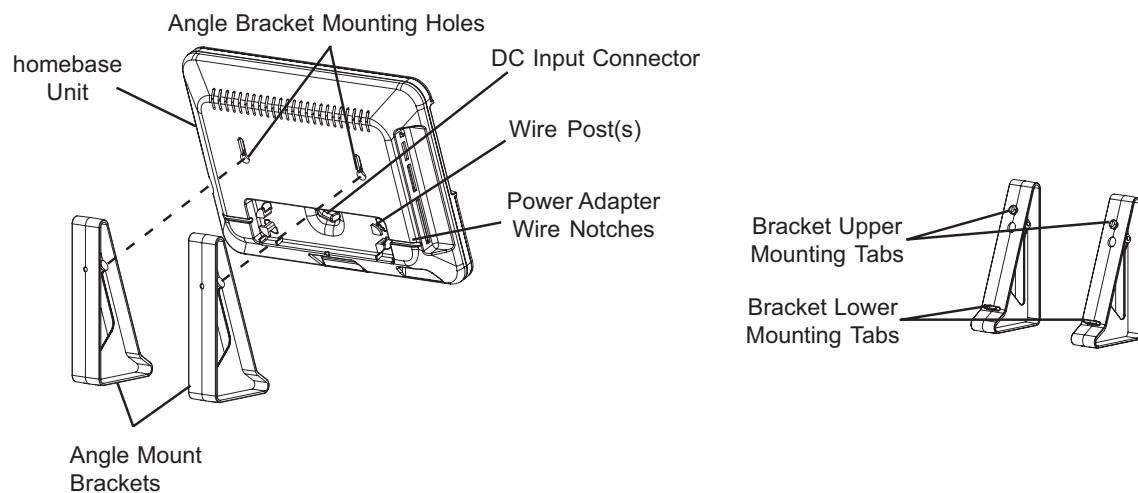

homebase Countertop Installation

1. Find a suitable location on the countertop adjacent to an AC wall outlet.
2. Connect the power adapter plug to the **DC** input connector at the rear of the homebase.
3. Choose the direction of the adapter wire in reference to the AC wall outlet. Place the DC wire in the corresponding wire notch.
4. Check the amount of wire required to reach the AC outlet. Spool excess wire on the four posts inside the rear cavity of the homebase.
5. Attach each angle mount bracket to the homebase by lining up the individual angle mount bracket upper mounting tab with the associated homebase mounting hole.
6. Push each angle mount bracket towards the top of the homebase until the upper mounting tab engages the mounting hole slot; when the bottom of the angle bracket contacts the homebase, the tab on the bottom of the angle bracket snaps into place.
7. Place the homebase in the desired location.

Installation (Cont)

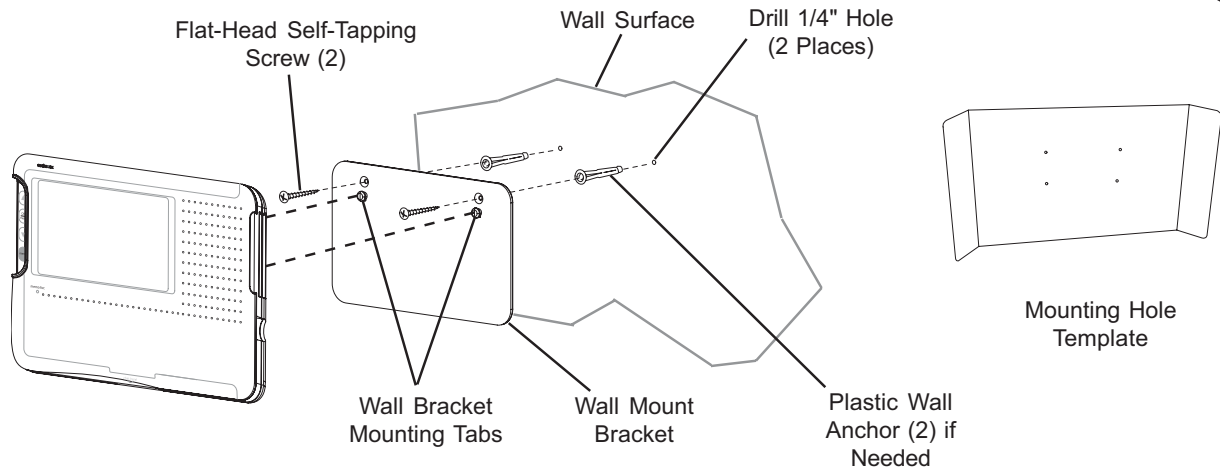

homebase Wall Mount Installation Using the Wall Mount Bracket

Note: If the wall bracket is to be mounted using the foam adhesive pads, the procedure will be the same as that for the refrigerator mount as described on page 7.

If the wall bracket is to be mounted using screws, proceed as follows:

1. Position the mounting hole template at the desired place on the wall; level the template and mark the position of the two upper holes.
2. Drill two holes using a 1/4" (6mm) drill bit. If a wall stud is not present, insert the plastic anchors into the holes until flush with the wall surface.

Caution: Do not over tighten the screws; otherwise, the wall bracket could be damaged

3. Align the wall bracket with the two holes and/or wall anchors; insert two flat-head screws and secure the wall bracket to the wall.
4. Connect the power adapter plug to the **DC** input connector at the rear of the homebase.
5. Choose the direction of the adapter wire in reference to the AC wall outlet. Place the DC wire in the corresponding wire notch.
6. Check the amount of wire required to reach the AC outlet. Spool excess wire on the four posts inside the rear cavity of the homebase.
7. Attach the homebase to the bracket by lining up the homebase bracket mounting holes with the wall bracket mounting tabs, and slide the homebase down until the mounting tabs engage the mounting hole slots.
8. Cover the power adapter wire with the clear, black or white wire cover; seal the cover using the double-sided tape and dress the wire, adhering it to the wall surface.

homebase™

Installation (Cont)

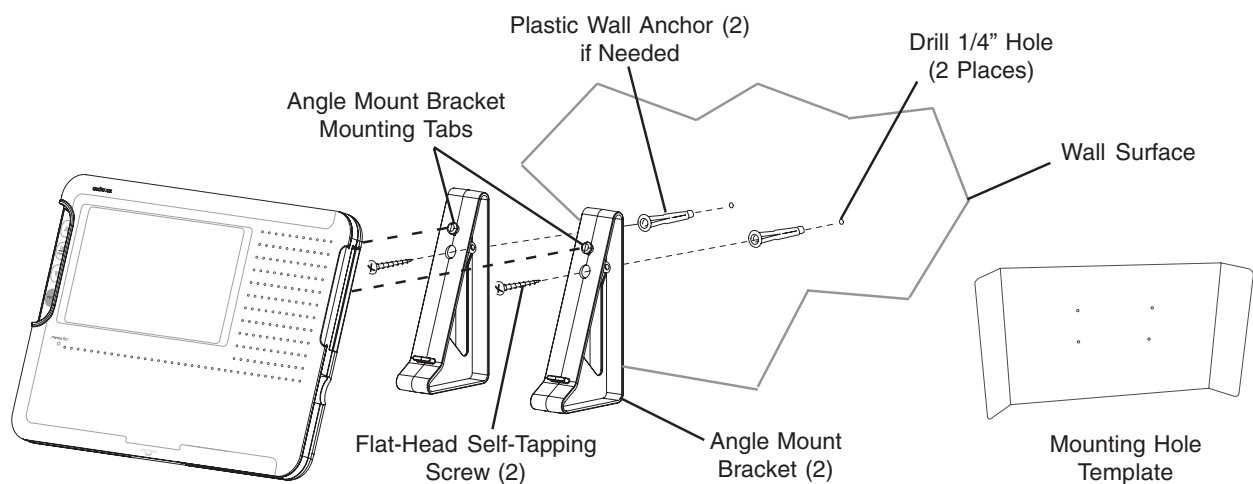

homebase Wall Mount Installation Using the Angle Mount Brackets

Note: Foam adhesive pads are not recommended when mounting the angle mount brackets to a wall surface.

Mount the brackets to the wall surface as follows:

1. Position the mounting hole template at the desired place on the wall; level the template and mark the position of the two lower holes.
2. Drill two holes using a 1/4" (6mm) drill bit. If a wall stud is not present, insert the plastic anchors into the holes until flush with the wall surface .

Caution: Do not over tighten the screws; otherwise, the angle mount bracket could be damaged.

3. Align each angle mount bracket with the respective hole and/or wall anchors; insert a flathead screw through each bracket and secure the bracket to the wall.
4. Connect the power adapter plug to the **DC** input connector at the rear of the homebase.
5. Choose the direction of the adapter wire in reference to the AC wall outlet. Place the DC wire in the corresponding wire notch.
6. Check the amount of wire required to reach the AC outlet. Spool excess wire on the four posts inside the rear cavity of the homebase.
7. Attach the homebase to each bracket by lining up the homebase bracket mounting hole with the associated bracket mounting tabs, and slide the homebase down until each mounting tab engages the mounting hole slot.
8. Cover the power adapter wire with the clear, black or white wire cover; seal the cover using the double-sided tape and dress the wire, adhering it to the wall surface.

homebase™

Installation (Cont)

Internal Battery Activation and/or Replacement

A type CR2032 battery is installed in a compartment behind the front panel of the homebase. If the unit is being used for the first time, the battery must be activated. A plastic insulator prevents contact with the battery terminals. This insulator must be removed for the calendar/clock backup functions to operate. To remove the insulator, simply pull out the plastic tab extending from the right side of the unit below the marker pen.

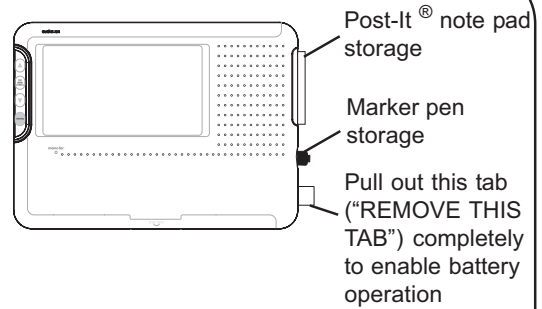

To remove and replace the battery, proceed as follows:

1. Lay the homebase on a flat surface with the front panel facing up.
2. Grasp the center of the front panel at the top and bottom edge and bow the panel out until it clears the left side by the control buttons. Remove the panel to reveal the battery compartment cover.
3. With your thumb, press the cover in the direction indicated by the arrow until it disengages. Lift off the cover.
4. Carefully remove the battery.
5. Insert the battery in the compartment paying special attention to battery orientation (+ side facing up).
6. Replace the battery compartment cover by first engaging the right-hand tabs in the slots. Then press down and slide the cover to the left to secure the cover in place.
7. Replace the front panel by engaging the right side under the protruding lip; then slightly bow the panel out and slide the left side under the lip by the control buttons.
8. The battery backup feature should now be operational.

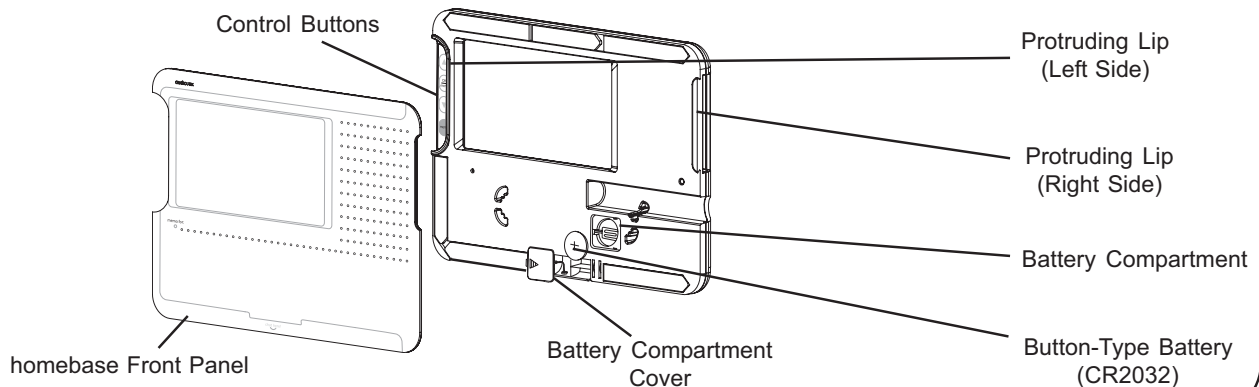

homebase™

Controls, Indicators and Connectors

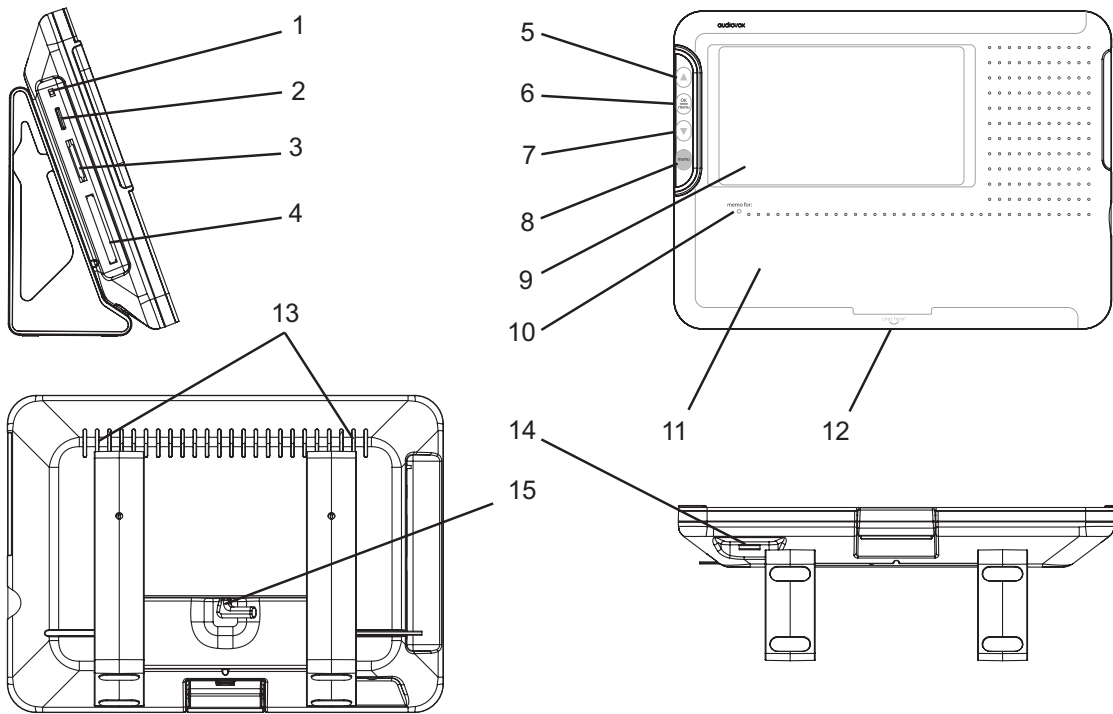

- 1. Power On/Off Switch
- 2. **USB** Connector
- 3. **SD/MMC/MS/XD** Connector
- 4. **CF** Connector
- 5. Up (▲) Navigation Button
- 6. **OK / MENU** Button
- 7. Down (▼) Navigation Button

- 8. **MEMO** Button
- 9. LCD Display
- 10. LED Indicator
- 11. Memo Writing Surface
- 12. Microphone
- 13. Speakers
- 14. - **Volume** + Control

- 15. **DC** Input Connector

homebase™

Accessory Placement

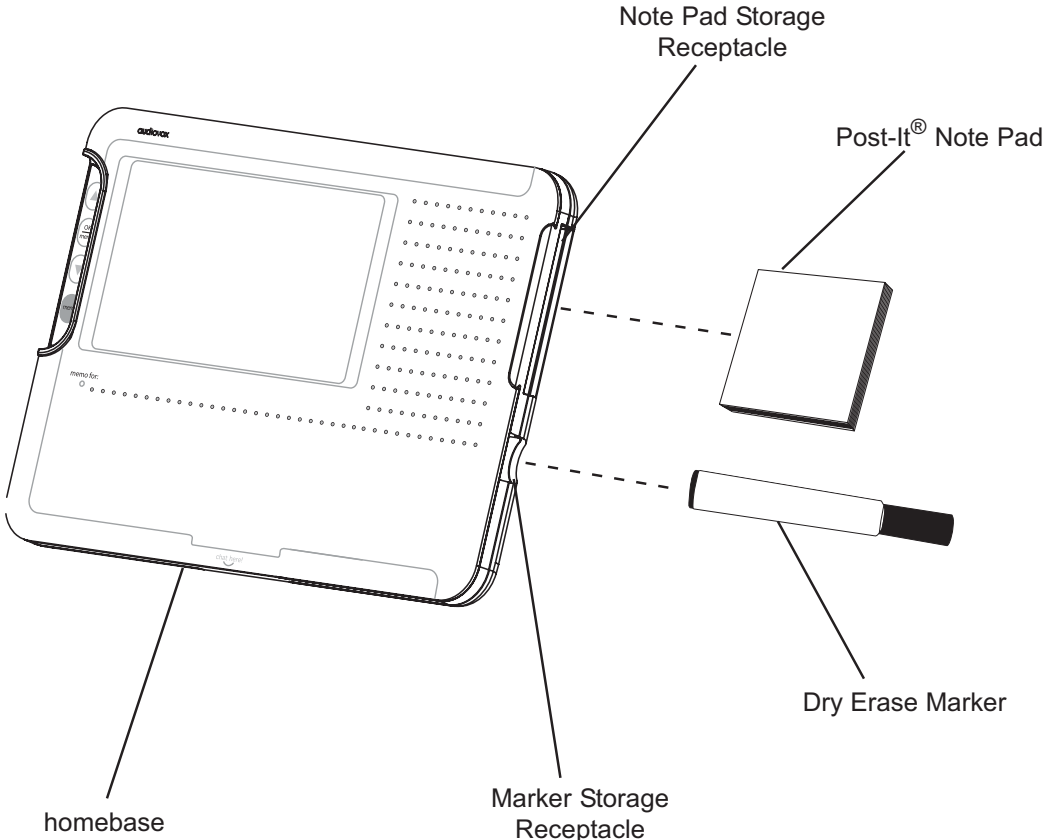

homebase™

Operating the homebase

Preliminary Connections

Prior to initial operation, connection must be made to the power source and the tab ("REMOVE THIS TAB") on the right side of the unit must be removed to enable backup battery operation.

Connecting the Power. Power to the homebase is provided by the AC-to-DC wall adapter which delivers +9VDC to the DC input connector at the rear of the unit. Refer to the installation procedures outlined previously for the methods involved in connecting the wall adapter plug to the power input connector, and the routing and dressing of the adapter power cable. The figure below illustrates a typical installation.

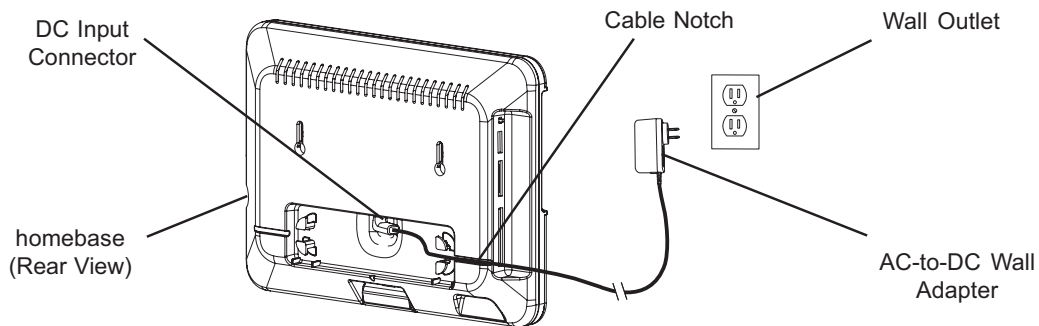

Inserting the Memory Card/USB Device. All of the memory devices attach at the left side of the homebase and can consist of a USB Flash Memory, Compact Flash (CF) Memory Card, Multi-Media Card (MMC), Memory Stick (MS) Card, Secure Digital (SD) Card, or an xD Card. All of these devices are inserted in their respective receptacles with the label side facing to the rear.

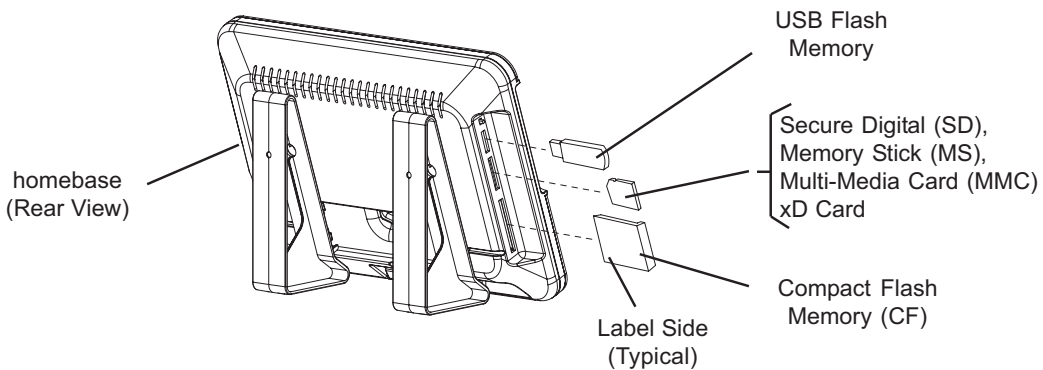

Power On/Main Menu

Preliminary Checks

With the homebase properly installed, perform the following precautionary checks prior to power application:

1. Make sure the power switch on the upper left side of the unit is in the Off (down) position.
2. Check the wall adapter and power cable for cuts, nicks, kinks, etc.
3. Plug the adapter plug into a wall outlet.

Power On/Main Menu

1. Place the power switch in the On (up) position. In a few seconds, the homebase logo appears on the LCD screen, followed about 5 seconds later by the slide show if an input memory device is connected; otherwise, the homebase demonstration (demo) slide show will start.
Note: The demo slide show images can be erased.
2. If the slide show is displayed, and the **OK / MENU** button is pressed, the main **menu** is displayed with **calendar** highlighted. If no input device is connected when power is applied, the Homebase logo remains on the screen until the **OK / MENU** button is pressed; the main menu appears once again.
3. If an input device containing pictures is connected while the main menu is displayed, the slide show thumbnail pictures are displayed.

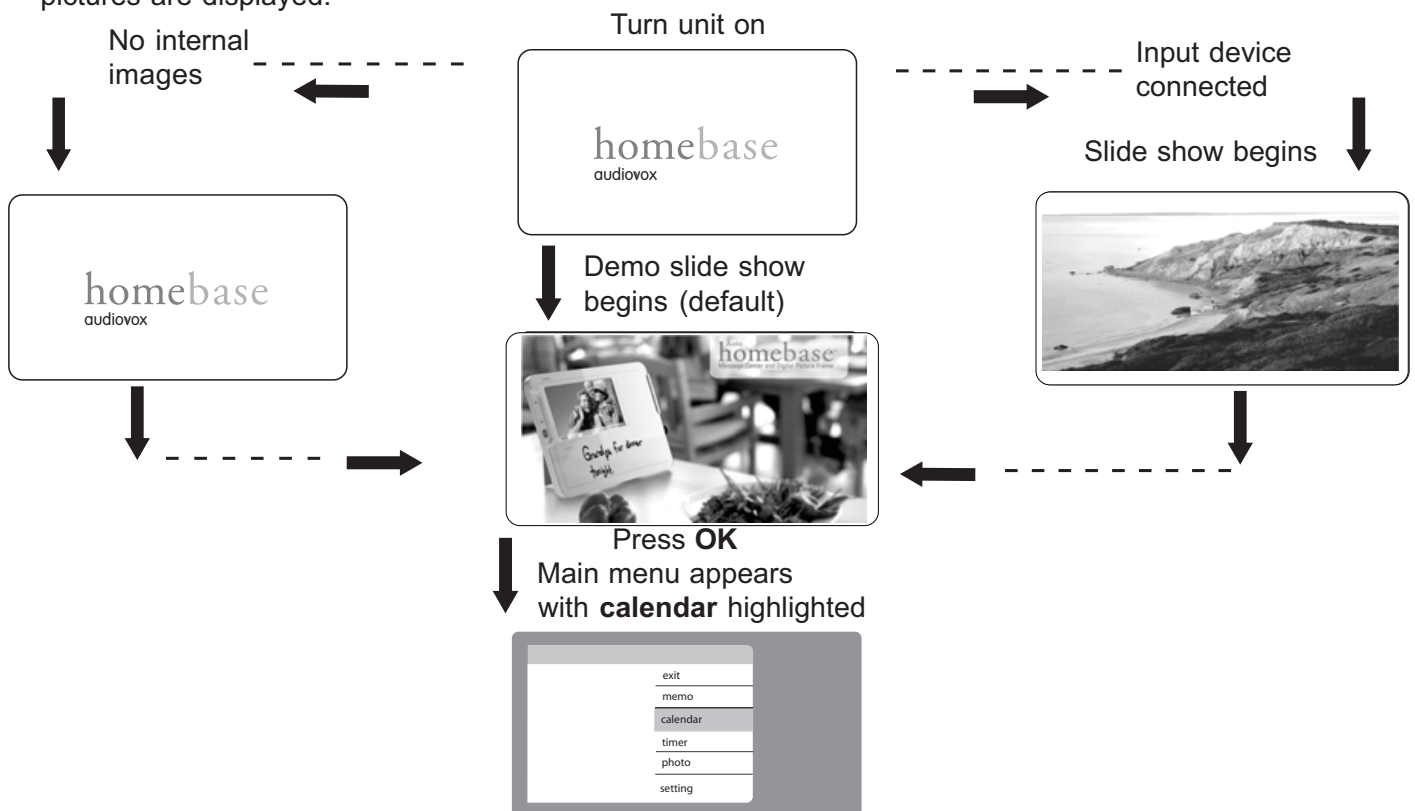

Memo Feature

Highlight **MEMO** in the main menu using the up/down buttons (▲/▼)

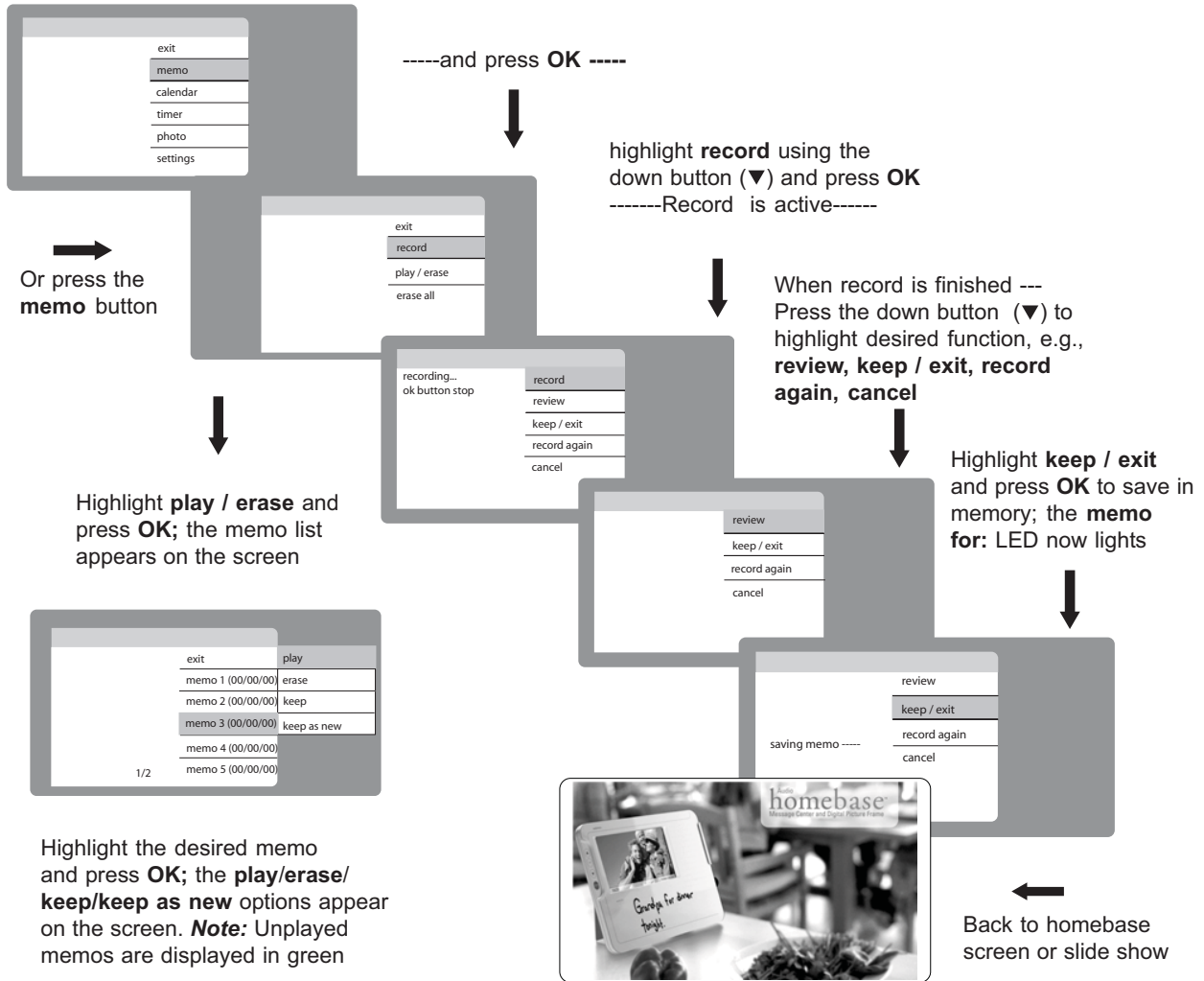

Calendar Memos

1. Recording Calendar Memos

Highlight **calendar** in the main menu using the up/down buttons (▲/▼)

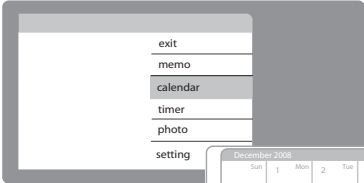

-----and press **OK**-----

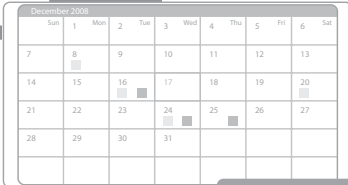

Press **MEMO** button and use the up/down buttons (▲/▼) to highlight **voice** or **event memo**

Note: Use the up/down buttons (▲/▼) to scroll from day to day and pressing and holding up/down buttons (▲/▼) for 2 seconds advances to the next month.

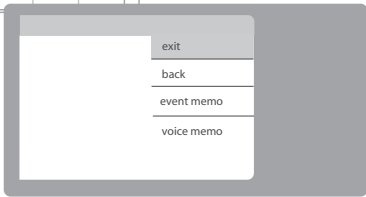

Note: Calendar voice memos automatically erase after 72 hours from the date the memo is set to play.

Highlight event memo and press **OK**

Highlight **voice memo** and press **OK**

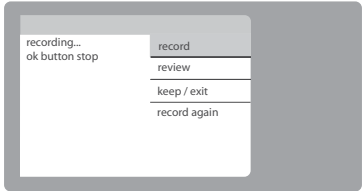
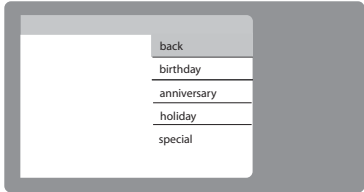

Press **OK** and use the up/down buttons (▲/▼) to highlight the event type. Press **OK** to set it on or as a **yearly reminder**; the event is flagged on the calendar screen by the appropriate icon.

Press **OK** to begin recording a voice message (refer to the memo feature described previously)

Calendar Memos (Cont)

2. Reviewing Calendar Memos

Highlight **calendar** in the main menu using the up/down buttons (▲/▼)

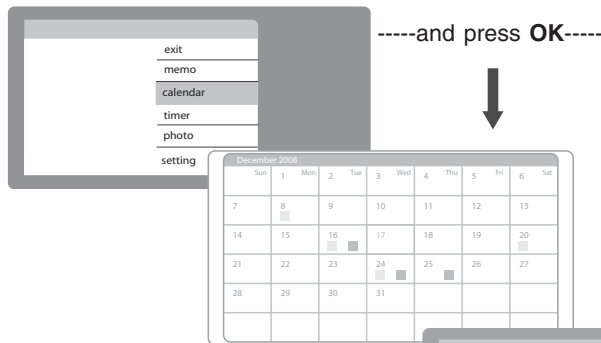

Note: Use the up/down buttons (▲/▼) to scroll from day to day and pressing and holding up/down buttons (▲/▼) for 2 seconds advances to the next month.

Press the **OK** button and use the up/down buttons (▲/▼) to highlight **voice or event memo**

Highlight event memo and press **OK**



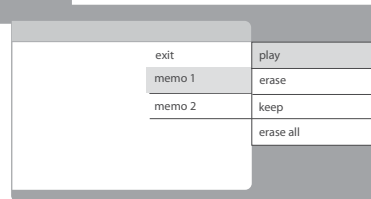

Highlight **voice memo** and press **OK**

When the calendar is displayed, press and hold the up or down button (▲/▼) more than 2 seconds to select the month; a momentary press of either button highlights the date

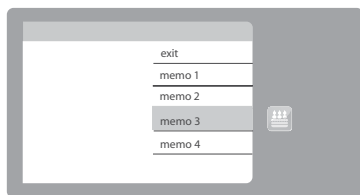

Note: Pressing **erase all** will erase all calendar voice memos.



-  Special Event Icon
-  Anniversary Reminder Icon
-  Birthday Reminder Icon
-  Holiday Reminder Icon

Countdown Timer

Highlight **timer** in the main menu using the up/down buttons (▲/▼)

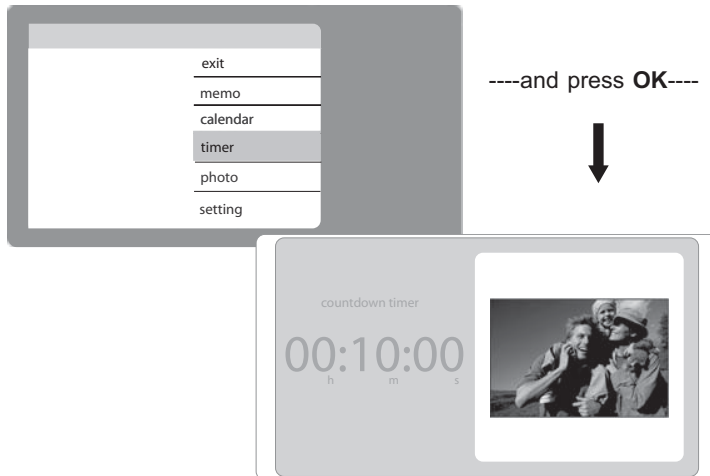

A split screen display appears with the countdown timer on the left and a slide picture on the right. If the slide show is in progress when the timer function is selected, the slide show stops at the current picture and appears in the timer display background.

- When the timer display appears, the hours (**h**) digits are flashing and **10** minutes is indicated.
- Use the up/down buttons (▲/▼) to set the hours and press **OK**.
- The minutes digits are now flashing; use the up/down buttons (▲/▼) to set the minutes (**m**) and press **OK**.
- The minutes digit decreases by 1 and the seconds (**s**) digits begin to count down from 59, initiating the countdown sequence.
- To terminate the countdown prior to timeout, press the **OK** button.
- If the countdown is allowed to time out, **time's up!** appears above the digits, the display automatically returns to the slide show and the alarm sounds for 2 minutes, or until the **OK** button is pressed.

Photo Menu

Highlight **photo** in the main menu using the up/down buttons (▲/▼)

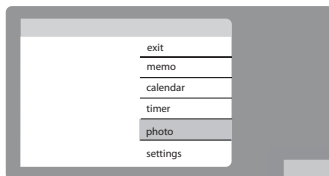

----and press **OK**----

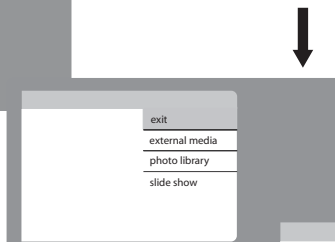

Highlight **external media** using the up/down buttons (▲/▼) and press **OK**

Highlight **USB, sd/mmc/xd/ms, or CF** using the up/down buttons (▲/▼) and press **OK**

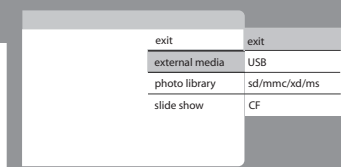

Highlight **photo library** using the up/down buttons (▲/▼) and press **OK** to access photos stored in the library file. If none exists, this feature is **not supported**. (See Photo Library Menu)

Highlight **slide show** using the up/down buttons (▲/▼) and press **OK**

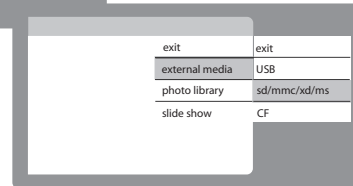

The display will show thumbnail images on a connected external media card, prioritizing SD/MMC/xD/MS over USB and CF. (See External Media Menu)

Select the slide show feature desired and press **OK**

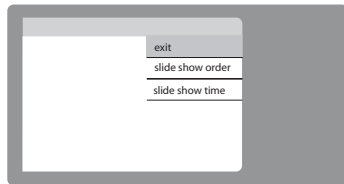

Determine the order in which the slide show pictures are to be shown and press **OK**

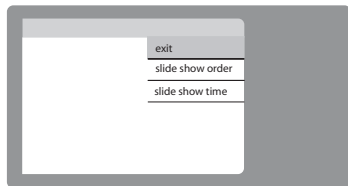

Determine how long each slide show picture remains displayed on screen and press **OK**

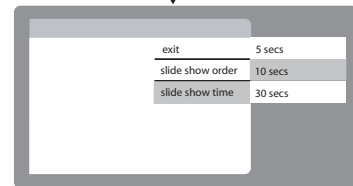
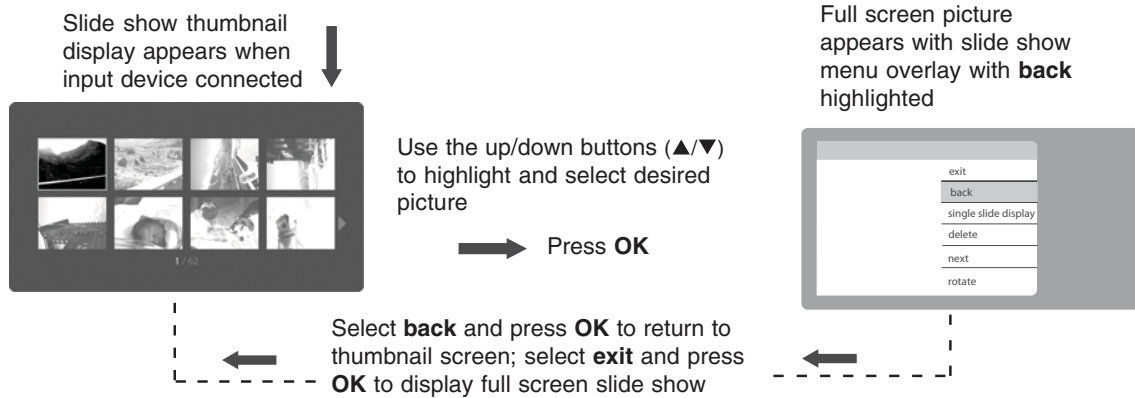
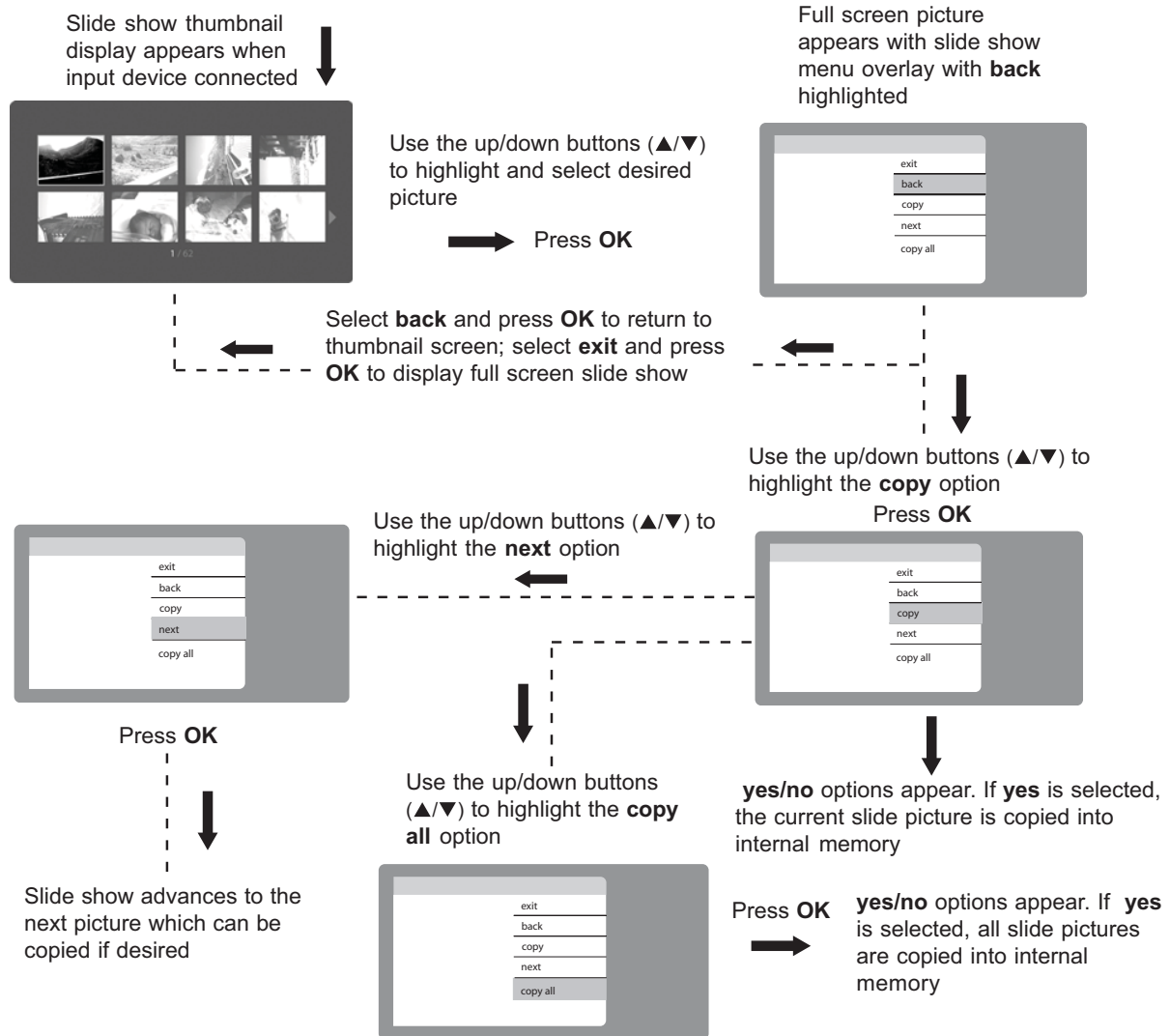

Photo Library Menu



- 1. Single Slide Display** - Stops slide show and displays only selected picture. To resume the slide show, turn the Single Slide Display function to off.
- 2. Delete** - Removes selected image from internal memory by selecting **yes**. Selecting **all** removes all images from internal memory.
- 3. Next** - Advances to the next slide in order after pressing the **OK** button.
- 4. Rotate** - Rotates the selected image in 90 degree increments.

External Media Menu



Settings

1. General Setup - Photo Mode Selection

Highlight **settings** in the main menu using the up/down buttons (▲/▼)

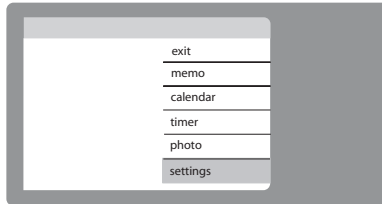

↓ and press **OK**

Highlight **general setup** using the up/down buttons (▲/▼)

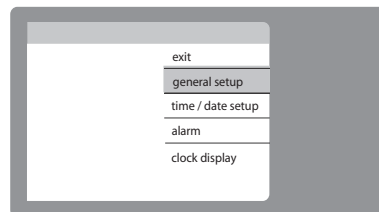

and press **OK**



1. **Photo Mode** - Select between normal mode and wide screen.
2. **Activation Time** - Set a time for the unit's display to turn off and turn on to conserve energy. Pressing any key while in the energy conservation mode will re-activate the display.
3. **Clear Memory** - Will delete all images and memos in memory.
4. **Default** - Restore all factory settings.

Settings (Cont)

2. General Setup - Time / Date Setting

- a. In the Settings menu, highlight **time / date setup** using the up/down buttons (▲/▼) and press **OK**.
- b. The time / date display appears with the hour digit(s) flashing.
- c. Use the up/down buttons (▲/▼) to set the hour and press **OK**.
- d. The minutes digits are now flashing; use the up/down buttons (▲/▼) to set the minutes and press **OK**.
- e. The **AM/PM** indication now flashes; use the up/down buttons (▲/▼) to set the **AM** or **PM** indication and press **OK**.
- f. On the top date line above the time, the month indication now flashes; use the up/down buttons (▲/▼) to set the month and press **OK**.
- g. Flashing now advances to the day of the month indication; use the up/down buttons (▲/▼) to set the day and press **OK**.
Note: When the day of the month and year are set correctly, the week day adjusts automatically to indicate the correct day of the week.
- h. Flashing now advances to the year indication; use the up/down buttons (▲/▼) to set the year and press **OK**.
- i. Time/date setup is complete and the display reverts to the Settings menu with **time/date setup** highlighted.



Settings (Cont)

3. General Setup - Alarm Setting

In the Settings menu, highlight **alarm** using the up/down buttons (▲/▼) and press **OK**

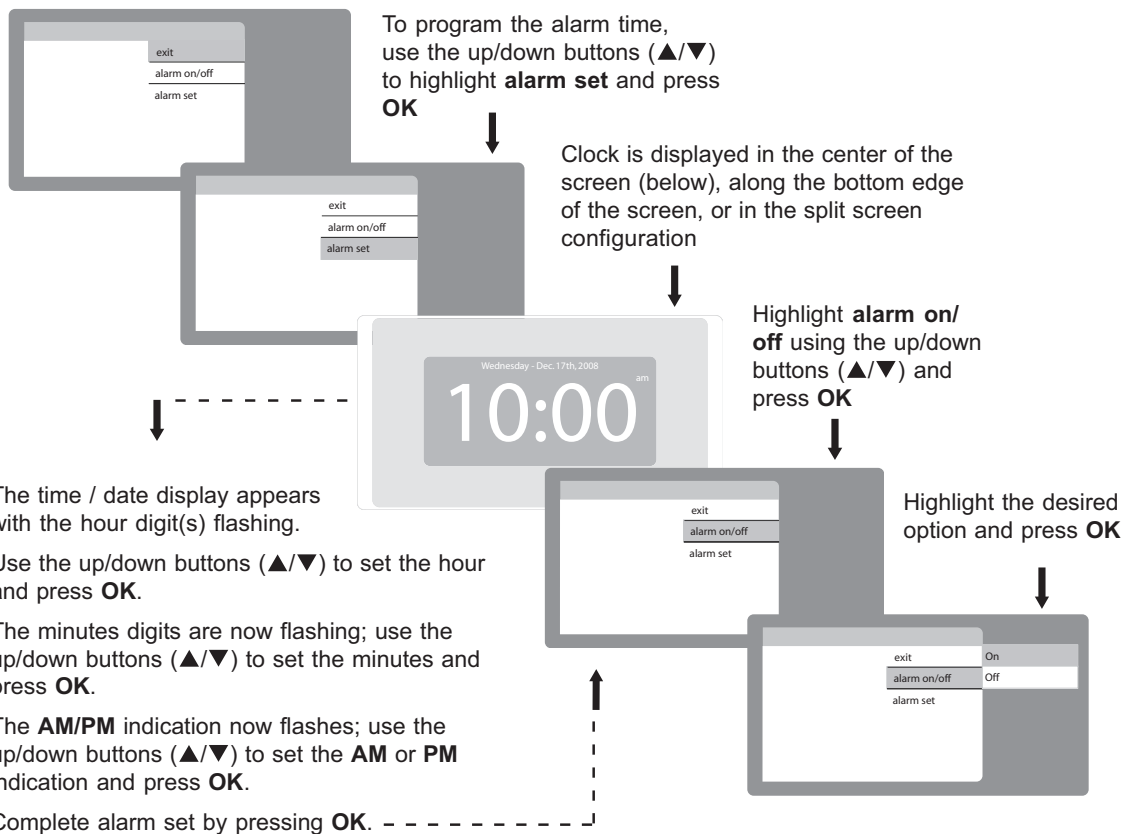

Note: If the alarm is set, the clock icon (🕒) is also displayed on the screen in each of the clock presentations described.

Settings (Cont)

4. General Setup - Clock Display

In the settings menu, to display the clock on the screen, highlight **clock display** using the up/down buttons (▲/▼)

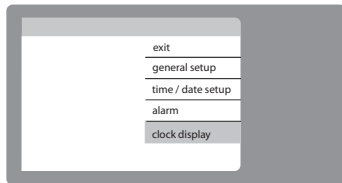

and press **OK**

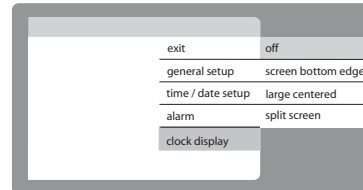

Select the clock presentation desired using the up/down buttons (▲/▼) and press **OK**

The clock can be positioned at the bottom edge of the screen, in large letters in the center of the screen, in the split screen configuration, or be turned off completely (**off**).



Clock icon displayed on bottom of screen



Clock icon displayed at left in split screen configuration

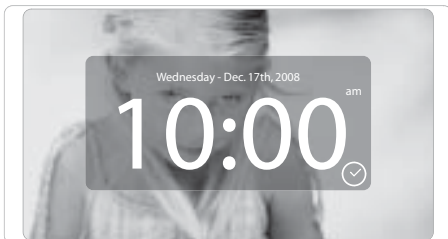

Clock icon displayed in center of screen

Technical Data

Specifications

- Digital Picture Frame 7" LCD
- Aspect Ratio 16:9
- Resolution: 480 x 234 pixels
- Internal Flash Memory 512 MByte
- USB Connector Provides interface for external USB memory device
- SD/MMC/MS/xD Card Slot Provides interface for memory device
- CF Connector Provides interface for CF memory device
- Date/Time Digital Calendar and Clock Feature
- Voice Messages Internal microphone for digital audio recording
- Audio Output Internal speakers (2) with separate volume control
- Menu Navigation 3 keys
- Message Indicator Green LED
- Reminder Function The **memo for:** LED will light when there is an unheard voice memo or an activated calendar voice memo
- Memory Backup for the Clock Internal backup battery data Infoetc. Battery type CR2032
- Image File Type Handling JPEG

homebase™

Warranty



AUDIOVOX®

90 DAY LIMITED WARRANTY

Applies to Audiovox Video Products

AUDIOVOX ELECTRONICS CORP. (the Company) warrants to the original retail purchaser of this product that should this product or any part thereof, under normal use and conditions, be proven defective in material or workmanship within ninety (90) days from the date of original purchase, such defect(s) will be repaired or replaced with reconditioned product (at the Company's option) without charge for parts and repair labor. A game controller, if supplied, is similarly warranted for ninety (90) days.

To obtain repair or replacement within the terms of this Warranty, the product is to be delivered with proof of warranty coverage (e.g. dated bill of sale), specification of defect(s), transportation prepaid, to the Company at the address shown below.

This Warranty does not extend to the elimination of externally generated static or noise, to correction of antenna problems, to costs incurred for installation, removal or reinstallation of the product, or to damage to digital memory/media devices, gaming devices, discs, speakers, accessories, or electrical systems.

This Warranty does not apply to any product or part thereof which, in the opinion of the Company, has suffered or been damaged through alteration, improper installation, mishandling, misuse, neglect, accident, or by removal or defacement of the factory serial number/bar code label(s). THE EXTENT OF THE COMPANY'S LIABILITY UNDER THIS WARRANTY IS LIMITED TO THE REPAIR OR REPLACEMENT PROVIDED ABOVE AND, IN NO EVENT, SHALL THE COMPANY'S LIABILITY EXCEED THE PURCHASE PRICE PAID BY PURCHASER FOR THE PRODUCT.

This Warranty is in lieu of all other express warranties or liabilities. ANY IMPLIED WARRANTIES, INCLUDING ANY IMPLIED WARRANTY OF MERCHANTABILITY, SHALL BE LIMITED TO THE DURATION OF THIS WRITTEN WARRANTY. ANY ACTION FOR BREACH OF ANY WARRANTY HEREUNDER INCLUDING ANY IMPLIED WARRANTY OF MERCHANTABILITY MUST BE BROUGHT WITHIN A PERIOD OF 12 MONTHS FROM DATE OF ORIGINAL PURCHASE. IN NO CASE SHALL THE COMPANY BE LIABLE FOR ANY CONSEQUENTIAL OR INCIDENTAL DAMAGES FOR BREACH OF THIS OR ANY OTHER WARRANTY. No person or representative is authorized to assume for the Company any liability other than expressed herein in connection with the sale of this product.

Some states do not allow limitations on how long an implied warranty lasts or the exclusion or limitation of incidental or consequential damage so the above limitations or exclusions may not apply to you. This Warranty gives you specific legal rights and you may also have other rights which vary from state to state.

Audiovox Electronics Corporation, 150 Marcus Blvd., Hauppauge, New York 11788 • 1-800-645-4994

128-5556G

Notes

A large, empty rectangular area with rounded corners, intended for taking notes. It is bounded by a thin black line.

homebase™

Notes

Notes

Large empty rounded rectangular box for notes.

Audiovox Electronics Corp.
150 Marcus Boulevard
Hauppauge, NY 11788

DPF710K

128-8269B