

**AUDIOVOX®**  
**ELECTRONICS CORP.**

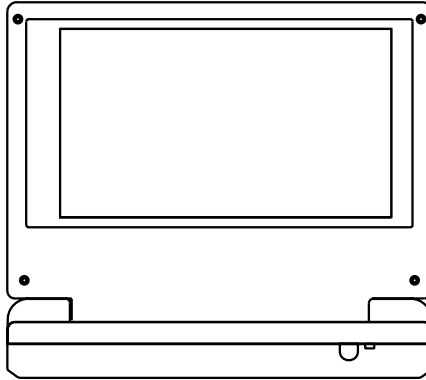

---

# D1708PK

**PORTABLE 7" LCD MONITOR AND DVD PLAYER  
IN A BAG**

---



For Customer Service  
Visit Our Website At  
**[www.audiovox.com](http://www.audiovox.com)**  
Product Information, Photos,  
FAQ's, Owner's Manuals

**Notice:**

This Product incorporates copyright protection technology that is protected by method claims of certain U.S. Patents and other intellectual property rights owned by Macrovision Corporation and other rights owners. Use of this copyright protection technology must be authorized by Macrovision Corporation, and is intended for home and other limited viewing uses only unless otherwise authorized by Macrovision Corporation. Reverse engineering or disassembly is prohibited.

**Notice:**

An LCD panel and/or video monitor may be installed in a motor vehicle and visible to the driver if the LCD panel or video monitor is used for vehicle information, system control, rear or side observation or navigation. If the LCD panel or video monitor is used for television reception, video or DVD play, the LCD panel or video monitor must be installed so that these features will only function when the vehicle is in "park" or when the vehicle's parking brake is applied.

An LCD panel or video monitor used for television reception, video or DVD play that operates when the vehicle is in gear or when the parking brake is not applied must be installed to the rear of the driver's seat where it will not be visible, directly or indirectly, to the operator of the motor vehicle.

## **A. Introduction**

Thank you for selecting the D1708PK portable DVD player in a bag. The main features include a 7" Screen (16:9 Aspect Ratio) Liquid Crystal Display (LCD) monitor and a DVD player. The unit applies the latest state of the art electronics and is designed for use in hotels, offices home or vehicle. The unit is constructed to provide years of reliable, trouble-free service, and is compact so that you can take it with you anywhere and is designed for quick and easy installation. Please read the entire instruction manual supplied with this product prior to operation. The documentation will assist you in installing the system properly to obtain the best equipment performance. All manuals should be stored for later use.

## **B. Cautions and Warnings**

### ***1. Placement***

To prevent fire or electric shock, do not expose this appliance to rain or moisture. Do not place the set on an unstable cart, stand, tripod, bracket or table to prevent it from falling. Keep the unit away from strong magnets, heat sources, direct sunlight, excessive dust. If the unit is brought directly from a cold to a warm location, moisture may condense inside the unit. When you move it from a cold to a warm location, wait for about one hour before operating the unit, or remove the disc and leave the unit turned on until the moisture evaporates.

### ***2. Installation***

Ensure that the D1708PK is installed in accordance with the instructions and illustrations provided in this manual.

### ***3. Object and Liquid***

Do not push objects of any kind into the unit through openings; do not spill or spray liquid of any kind on or in the system (this may result in a fire or electric shock). Do not place anything heavy on the unit. To ensure proper ventilation and proper operation, never cover or block the slots and openings with a cloth or other material.

### ***4. Disassembly***

Do not attempt to disassemble the cabinet. There is a risk of electric shock and/or exposure to Laser Radiation. Contact qualified service personnel if your system is in need of repair.

## **5. Cleaning Unit**

When cleaning, make sure the system is unplugged from the power source. Do not use liquid cleaners or aerosol cleaners. Use a cloth lightly dampened with water for cleaning the exterior of the system only.

## **6. Disc**

Do not use irregularly shaped discs such as heart or star-shaped discs as they may cause the unit to malfunction. Do not stick paper, tape or glue on the disc. Do not expose the disc to direct sunlight or heat sources such as hot air ducts. Do not touch the surface of disc. Handle the disc by its edge. Clean the disc by wiping the disc from the center out with a cleaning cloth. Remove the disc from the unit and store it in its case after playing. Some playback operations of discs may be intentionally fixed by software producers. Since this unit plays discs according to the disc contents the software producers designed, some playback features may not be available. Also refer to the instructions supplied with the discs.

## **C. Contents**

1. 1 x 7" LCD Monitor & DVD Player Combo
2. 1 x AC to DC Adapter
3. 1 x Remote Control w/Battery (CR2025)
4. 1 x Instruction Manual
5. 1 x Audio/Video Cable
6. 2 x Wired Headphones
7. 1 x DC Adapter
8. 1 x Mounting Bag w/Straps
9. 1 x Carrying Bag
10. 1 x Rechargeable Battery Pack

## **D. Powering and installation**

### **1. Powering the system indoors** (Refer to Figure 1)

Plug one end of the AC to DC adapter into the DC 9V jack on the right side of the main unit, then plug the other end into the 120V AC power receptacle.

## 2. Powering the system in a car

Plug one end of the cigarette lighter adapter into the DC 9V jack on the unit, then plug the other end into the lighter socket.

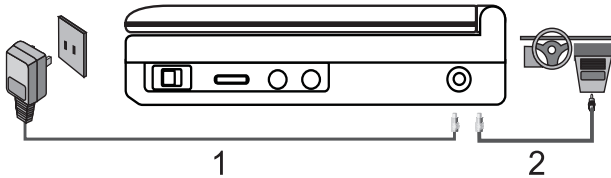

Figure 1

## 3. Powering the system with rechargeable Battery

Please refer to L. \* Rechargeable Battery Installation and Use (Page 32 and 34).

## E. Installation in Mounting Bag

Make sure that the unit is placed into the bag with the clear plastic covering around DVD door, Load disc into the DVD compartment and then fasten the Velcro strap across the top portion of the unit. If you are installing the bag onto the seatback you will need to attach the supplied Seat Standoff to the back of the mounting bag with the Velcro bands to obtain the proper viewing angle as shown in Figure.2

## **1. Installing the System onto the seat back in a car**

(Refer to Figure 2)

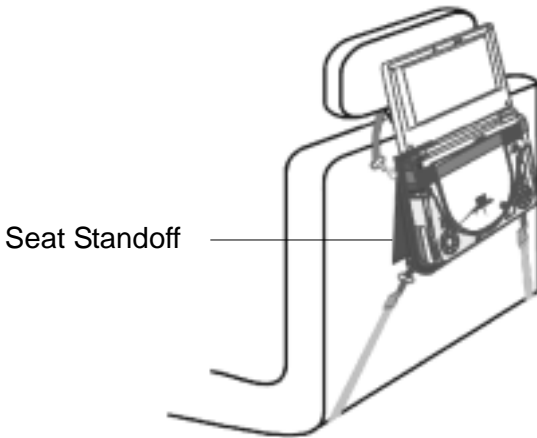

**Figure 2**

- 1). Take one of the supplied straps from the carrier bag. Connect the latch to one of the upper metal rings on the mounting bag. Connect the "S" hook to the other upper metal ring and place the loop over the headrest. Adjust the strap until the bag is firmly secured.
- 2). Take another strap from the carrier bag, and connect the latch to the lower metal ring on the left side of the bag. Attach the "S" hook to the same ring after looping the strap around the seat rail. Repeat this process for the right side. In some vehicles, it may be necessary to attach the "S" connector to the rail directly, as it may not be long enough to reach back to the ring.
- 3). Adjust the straps tightly so that the bag is secured.

**2. Installing the system between the driver/passenger seat**  
(Refer to Figure 3)

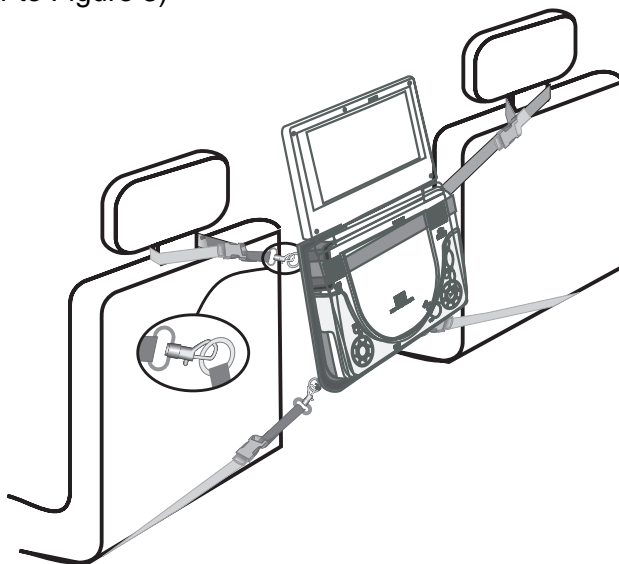
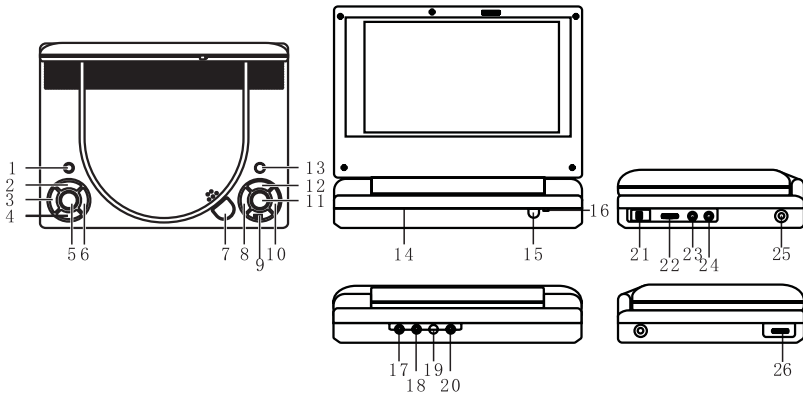

**Figure 3**

- 1). Take one strap and connect the latch to the upper metal ring on the left side of the bag. Attach the "S" hook to the same ring after looping the strap around the headrest of the driver's seat. Repeat this process for the right side (Passenger Seat).
- 2). Take another strap and connect the latch to lower metal ring on the left side of the bag. Attach the "S" hook to the same ring after looping the strap around the driver's seat rail. Repeat this process for the right side. In some vehicles, it may be necessary to attach the "S" connector directly to the rail, as it may not be long enough to reach back to the ring.
- 3). Adjust the straps tightly so that the bag is secured.

## E. Controls, Indicators, and Connectors

### 1. Unit View (Refer to Figure 4)



**Figure 4**

- |                    |                                |
|--------------------|--------------------------------|
| 1) Menu            | 13) Screen Mode (WIDE) Button  |
| 2) UP Button       | 14) Monitor Off Button         |
| 3) Left Button     | 15) Remote Control Sensor      |
| 4) Down Button     | 16) Power LED                  |
| 5) OK Button       | 17) DVD Video Output Jack      |
| 6) Right Button    | 18) DVD Audio L+R Output Jack  |
| 7) Open Button     | 19) Video Input Jack           |
| 8) Previous Button | 20) Audio L+R Input Jack       |
| 9) Stop Button     | 21) Power On/Off Switch        |
| 10) Next Button    | 22) Volume Up/Down control     |
| 11) Play button    | 23) Headphone Jack 1           |
| 12) Pause          | 24) Headphone Jack 2           |
|                    | 25) DC 9V Input Jack           |
|                    | 26) Brightness Up/Down control |



## 2. Remote Control View (Refer to Figure 5)

- 1) Display Button
- 2) Angle Button
- 3) Subtitle Button
- 4) Audio Button
- 5) Zoom Button
- 6) UP/DOWN/LEFT/RIGHT/ENTER Buttons
- 7) Return Button
- 8) A-B Button
- 9) Forward Button
- 10) Reverse Button
- 11) Slow Button
- 12) Stop Button
- 13) Numeric Keypad
- 14) Setup Button
- 15) Menu Button
- 16) Repeat Button
- 17) SKIP-
- 18) SKIP+
- 19) Play Button
- 20) Pause Button

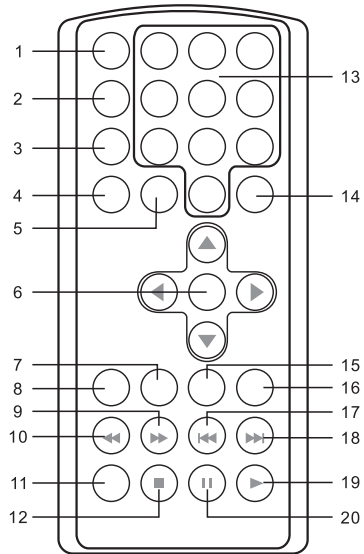

**Figure 5**

## F. Loading and Playing a Disc

- a. After connecting power to the unit, power on the “DVD player” with the power switch. The power indicator will light.
- b. Open the disc tray by pressing OPEN , and place a disc into the tray with the label side facing up.
- c. Close the tray by pressing the “PRESS” button. The unit will load the disc and start playing.
- d. Rotate the BRIGHTNESS and VOLUME controls to adjust the LCD’s brightness and the DVD player’s volume.
- e. To stop playing a disc, press STOP.
- f. To turn off the DVD player, slide the POWER ON/OFF to OFF. The DVD player’s POWER indicator turns off.

## G. SETUP

Press 'SETUP' to display the Main screen of the SETUP Menu on the screen. Press 'SETUP' again to exit the SETUP Menu and the unit will resume it's last playback mode.

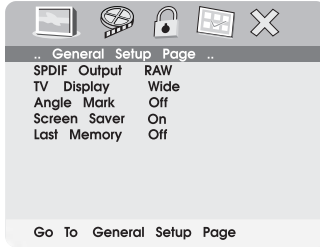

**Figure 6. Main SETUP Menu Screen**

1) Press "Setup", the 'GENERAL SETUP PAGE' will display on screen.

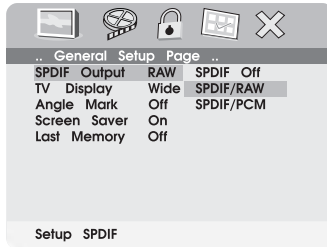

**Figure 7. General SETUP Menu Screen**

a).Select TV DISPLAY using the DOWN button, and then press RIGHT to enter the submenu. Select the TV display mode on the screen using UP/DOWN, and press ENTER to confirm the setting. Press LEFT to return.

- \* NORMAL/PS: When the player is connected to a normal TV, and a wide picture is shown on the full screen.
- \* NORMAL/LB: When the player is connected to a normal TV, and a wide picture is shown on the screen with a black strip at both the top and bottom of the screen.
- \* WIDE: When the player is connected to a wide screen TV, a wide picture is shown on the full screen.

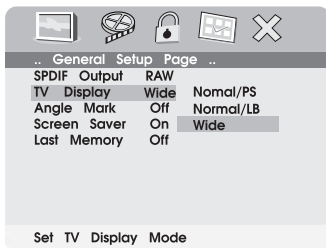

**Figure 8. TV DISPLAY Screen Display**

- b). Select 'ANGLE MARK' using the DOWN button, and then press the RIGHT button to enter the submenu. Choose Angle Mark on or off using the UP/DOWN buttons and then press ENTER to confirm the setting. Press the LEFT button to return.

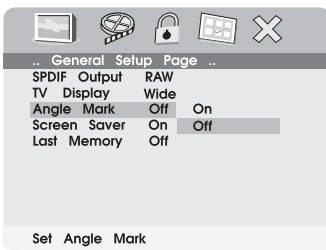
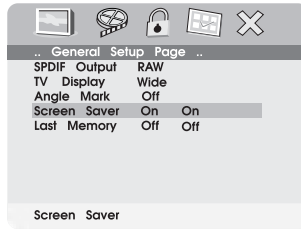

**Figure 9. ANGLE MARK Screen Display**

- \* ON: The screen will show the angle mark icon. (\*If an angle option is available).
- \* OFF: The screen will not display the Angle Mark icon.

**NOTE:** Not all discs contain above features.

c). Select 'SCREEN SAVER' using the DOWN button.



**Figure 10. SCREEN SAVER Display**

\*ON: enables screen saver

\*OFF: disables screen saver (off)

**\*NOTE:** The DVD player will enter the Screen Saver mode after approximately five minutes if the same image remains on the screen.

d). Select "Last Memory" by using the DOWN button.

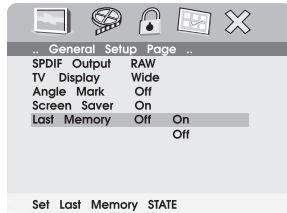
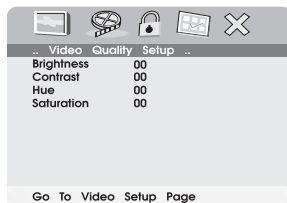

**Figure 11. LAST MEMORY Screen Display**

\*ON: The unit will return to the last position on the disc.

\*OFF: The unit will not return to the last position on the disc.

2) With no disc inside the player select "Video quality Setup" by using the LEFT/RIGHT buttons, press "enter" to enter the video quality set up page.



**Figure 12. Main SETUP Menu VIDEO QUALITY**

- a).Select “Brightness by using the UP or DOWN buttons ,then press “Enter”you can change the Brightness by pressing the LEFT or RIGHT buttons. To exit “Brightness Setting”, press “Enter”again to return the main Menu.

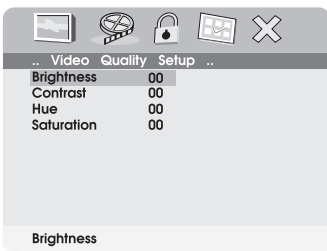

**Figure 13. BRIGHTNESS Screen Display**

- b).Select “Contrast” by using the UP or DOWN buttons,then press “Enter” you can adjust the Contrast by pressing the LEFT or RIGHT buttons.



**Figure 14. CONTRAST Screen Display**

To exit “Contrast” Setting, press “Enter”again to return to the main Menu.

- c).Select “Hue” by using the UP or DOWN buttons, then press “Enter” you can adjust the Hue by pressing the LEFT or RIGHT buttons.

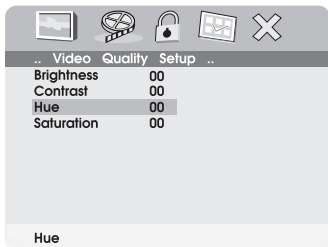

**Figure 15. HUE (Tint) Screen Display**

To exit “Hue”Setting,press “Enter”again to return the main Menu.

d).Select “Saturation “ by using the UP or DOWN buttons, then press “Enter” you can adjust the Saturation by pressing the LEFT or RIGHT buttons.

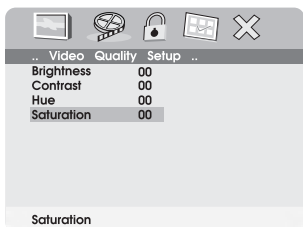

**Figure 16. SATURATION (Color)Screen Display**

To exit “Saturation”Setting,press “Enter”again to return to the main Menu

3).With no disc inside the player ,select “password” using the LEFT or RIGHT buttons, then press the ENTER button, then press the right button to enter the submenu.

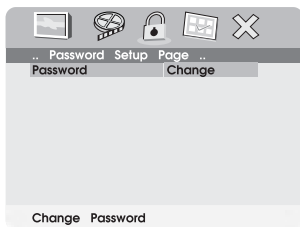

**Figure 17. PASSWORD CHANGE Menu**

Press ‘ENTER’ to enter the Password Change Page. Input the Old Password or the Default Password, the New Password, and the Confirmed New Password. Press ‘ENTER’ to confirm the change.

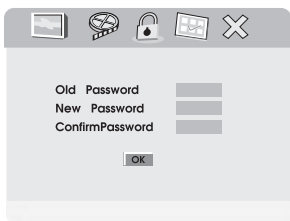

**Figure 18. PASSWORD CHANGE MENU**



**Figure 19. PASSWORD VERIFY Input Screen isplay**

**NOTE:** The Default Password is **3308**. This password is always effective even after you have selected your own password and changed it. To avoid the possibility of others using the default password to set the parental level and change the password, you can record this default password in another area and delete it from this manual. Some discs can be limited depending on the age of users while some discs cannot.

- 4). With no disc inside the player select 'PREFERENCES' using the LEFT or RIGHT buttons, then press 'ENTER' to enter the preferences page.

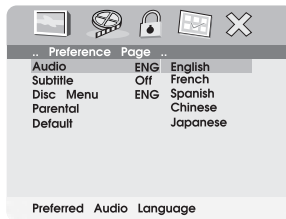

**Figure 20. Preference Audio Language**

- a. Select 'AUDIO' using the DOWN button, then press 'RIGHT' to enter the submenu. Select the audio language you desire using the UP or DOWN buttons, then press 'ENTER' to confirm the setting. Press LEFT to return.

- b. Select 'SUBTITLE' using the DOWN button, then press RIGHT to enter the submenu. Select the desired subtitle language or SUBTITLE OFF using the UP or DOWN buttons , then press 'ENTER' to confirm the setting. Press 'LEFT' to return.

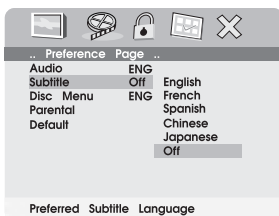

**Figure 21. Preference SUBTITLE LANGUAGE**

- c. Select 'DISC MENU' using the DOWN button, then press 'RIGHT' to enter the submenu. Select the Disc Menu Language you desire using the UP or DOWN buttons , then press 'ENTER' to confirm the setting. Press 'LEFT' to return.

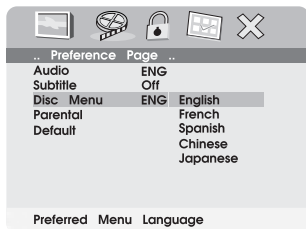
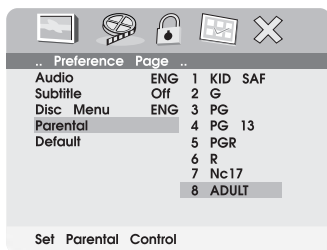

**Figure 22. Preference DISC MENU LANGUAGE**

**Note:** Language and subtitle selection is only available for discs that are recorded in the above listed languages. If the selected, language is not available, the player will play and display on the screen the original recorded language contained in the disc.



- d. Select 'PARENTAL' using the DOWN button, then press RIGHT to enter the submenu.



**Figure 23. PARENTAL Preference Screen Display**

Select the parental level you desire using the UP or DOWN buttons for discs with lock-out function or multiple rating levels. These are listed from the lowest level (1 Kid Safe) to the highest level (Adult). Enter a 4 digit password, then press 'ENTER' to confirm the parental level setting.

**NOTE:** The level of 8 Adult is the factory default.

- e. Select 'DEFAULTS' using the DOWN button, then press RIGHT to enter the submenu. Press ENTER to make the setting return to the factory-set mode.

**NOTE:** The parental setting is not affected by the default reset function.

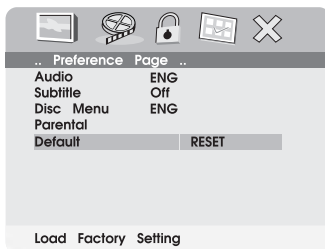

**Figure 24. Loading Factory Setting**

## 1. Basic Operation

POWER	Turn the unit on/off
OPEN	Remove/load the disc
PLAY	Start Play/Execute item or setting
SLOW	Play at 1/2, 1/4, 1/8 or 1/16 times speed
PAUSE	Still Picture
STOP	(1 time) Stop at the present playing point / (2 times) Stop playing
NEXT	Go to the next chapter, track or scene during play back
PREVIOUS	Go back to the previous chapter, track or scene during play back
FORWARD	Scan forward at 2, 4, 8,16 or 32x times speed
REVERSE	Scan backward at 2, 4, 8, 16 or 32x times speed
LEFT/RIGHT/UP/DOWN	Used for Menu Navigation
ENTER	Execute item or confirm setting
NUMBERS	Select item or setting
RETURN	Return
MENU	Display the main menu of the disc
REPEAT	Repeat playing title, chapter, or track
A-B	Repeat a specific portion from point A to point B of the disc
DISPLAY	Display information (title, chapter, track, time, etc.).
ANGLE	Change the viewing angles on the scene
SUBTITLE	Select the subtitle language and turn it on/off
AUDIO	Select the audio language
ZOOM	Enlarge an image to 2, 3, or 4 times the original size.
SETUP	Display the setup menu to select and set items, and exit the setup menu.

## 2. MENU

A DVD is divided into sections called titles and chapters. When you play a DVD, a root menu of the disc will appear on the screen of your TV or Monitor. The contents of the menu vary from disc to disc. Press MENU during playback to display the menu. Some DVDs only allow you to select disc playback options using the DVD root menu.

## 3. DISPLAY *(Display contents vary from disc to disc.)*

### 1. PLAYING TIME AND REMAINING TIME

- a. During playback press the 'DISPLAY' button to display the current Title Number (1), the total Number of Titles (2), the current Chapter Number (3), the total Number of Chapters (4), and the Playing elapsed Time for the title (5). The heading will disappear automatically after 3 seconds if no buttons are pressed.

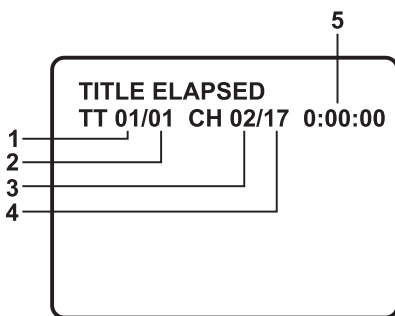

**Figure 25. Title, Chapter Number, and Time Screen Display**

- b. Press 'DISPLAY' again to display the Remaining Time of the title. The heading will disappear automatically in 3 seconds.

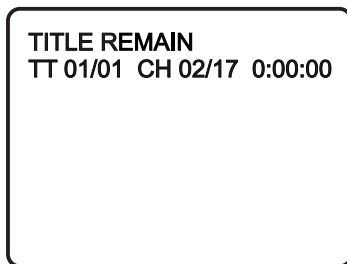

**Figure 26. Title Remaining Time Screen Display**

- c. Press 'DISPLAY' a 3rd time to display the Elapsed Time for the chapter. The heading will disappear automatically in 3 seconds.

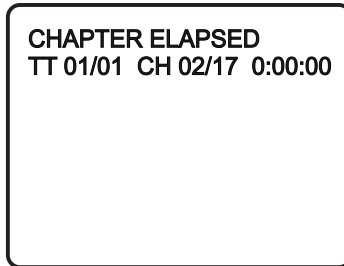

**Figure 27. Chapter Elapsed Time Screen Display**

- d. Press 'DISPLAY' a 4th time to display the Remaining Time for the chapter. The heading will disappear automatically in 3 seconds.

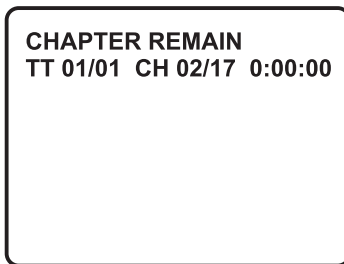

**Figure 28. Chapter Remaining Time Screen Display**

- e. Press 'DISPLAY' a 5th time to exit, 'DISPLAY OFF' will be displayed and will disappear automatically in 3 seconds.

## **2. ANGLE**

During playback of a disc, press 'ANGLE' to display the available angles for discs containing multi-angles\*, with the current angle number (1) and the total number of angles (2) displaying. Press 'ANGLE' to select another angle, then press again to exit and return to the normal viewing angle. The angle display will disappear automatically if the 'ANGLE' button is not pressed again within 3 seconds.

**\*NOTE:** Not all discs contain this feature.



**Figure 29. Angle Screen Display**

### **3. SUBTITLE**

During disc playback press 'SUBTITLE' to select the subtitle language you desire\*, with the current Subtitle Language Number (1) and the total Number of Subtitle Languages (2) displayed. If there are multiple languages press 'SUBTITLE' again to select another subtitle language. To turn subtitles OFF, press the 'SUBTITLE' button until 'SUBTITLE OFF' is displayed. The Subtitle display will disappear automatically if the 'SUBTITLE' button is not pressed again within 3 seconds.

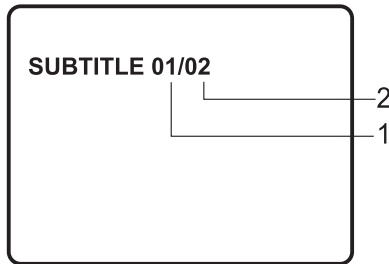

**Figure 30. Subtitle Screen Display**

\* Some DVDs only allow access to this function through the DVD menu.

#### 4. AUDIO

During playback press 'AUDIO' to select the audio language you desire\*, with the current Audio Channel Number (1) and the total number of Audio Channels (2) displayed. Press AUDIO again to select another audio language. The audio display will disappear automatically if the 'AUDIO' button is not pressed within for 3 seconds.

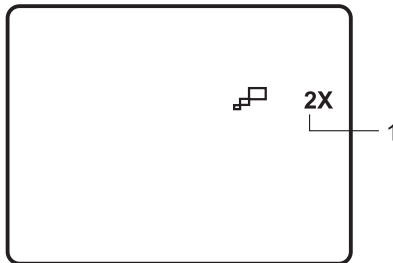

**Figure 31. Audio Language Screen Display**

\* Some DVDs only allow access to this function through the DVD menu.

#### 5. ZOOM

During playback press 'ZOOM' to enlarge the picture by 2x, 3x or 4X with the current zoom multiple.(1)Press "zoom"one time ,the picture will be enlarged 2X.(2)Press "zoom a "second time ,the picture will be enlarged 3X.(3)Press "zoom a "3rd time ,the picture will be enlarged 4X.(4)Press "zoom" a 4th time ,the picture will return to normal size.



**Figure 32. ZOOM Screen Display**

**6. A-B REPEAT**

- a. During playback press first time 'A-B' to set the Starting Point A.

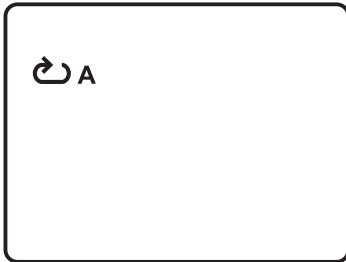

**Figure 33. A-B Repeat Starting Point Screen Display**

- b. Press 'A-B' second time to set the Ending Point B and the player will repeatedly play the part between Point A and Point B.

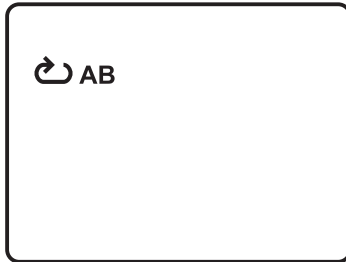

**Figure 34. A-B Repeat Ending Point Screen Display**

- c. Press A-B a third time to cancel A-B repeat and resume playback.

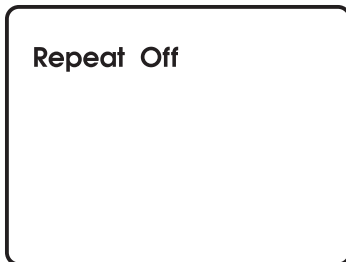

**Figure 35. A-B Repeat Cancelled Screen Display**

## 7. REPEAT

- a. During playback press 'REPEAT' once to repeatedly play the current chapter.

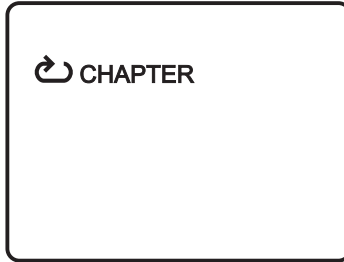

**Figure 36. Chapter Repeat ON Screen Display**

- b. During playback press 'REPEAT' again to repeatedly play the current title.



**Figure 37. Title Repeat ON Screen Display**

- c. During playback press 'REPEAT' a 3rd time to repeat all Chapters and Titles.



**Figure 38. All Repeat ON Screen Display**



d. Press "REPEAT" a 4th time, to resume normal play.

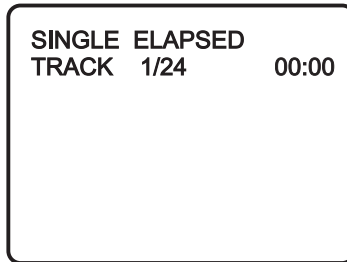

**Figure 39. Repeat Off Screen Display**

#### **4. PLAYING AUDIO CDS**

When playing an audio CD press the DISPLAY button on the remote to view time information. The options below show you what information is available using this function.

a. The current track and playing time of that track will be displayed on the screen.



**Figure 40. SINGLE ELAPSED Screen Display**

b. Press 'DISPLAY' one time and *SINGLE REMAIN* appears along with the current track playing and the amount of time left.

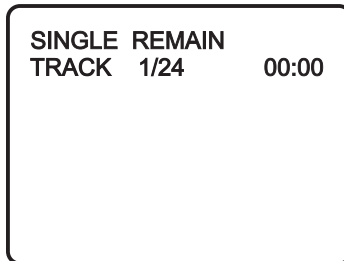

**Figure 41. SINGLE REMAIN Screen Display**

- c. Press 'DISPLAY' two times and *TOTAL ELAPSED* appears along with the current track playing and the total time that the CD has been playing.

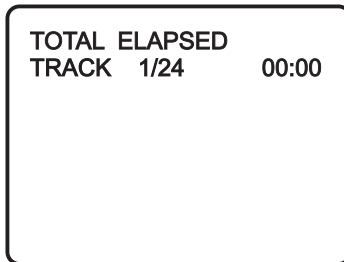

**Figure 42. TOTAL ELAPSED Screen Display**

- d. Press 'DISPLAY' three times and *TOTAL REMAIN* appears along with the current track playing and the amount of time remaining on the CD.

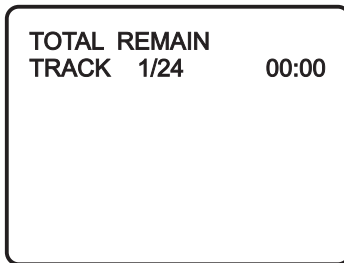

**Figure 43. TOTAL REMAIN Screen Display**

- e. Press 'DISPLAY' four times and "*DISPLAY OFF*" will appear momentarily then disappear. The CD time Information will not be displayed.

## **USING THE REPEAT FEATURE**

The default mode for the Repeat feature is OFF. Pressing REPEAT consecutively changes the repeat options:

- *TRACK*- repeats the track that is playing.
- *ALL*- repeats the disc that is playing.
- *OFF*

As you toggle through the options, the repeat option changes. The selected repeat option loops repeatedly until you turn it off.

## 5. PLAYING MP3 DISCS

MP3 is a format for storing digital audio. An audio CD-quality song is compressed into the MP3 format with very little loss of audio quality while taking up much less disc space. CD-R /RW discs that have been encoded in MP3 format are compatible with this system.

Playback modes:

**FOLDER** (normal playback)

**SINGLE**

**REPEAT ONE** (repeat playback of a song)

**REPEAT FOLDER** (repeat playback of a specific folder)

Insert an MP3 CD, the DVD player will initialize the disc and the directory (folder) will be shown on the TV screen.

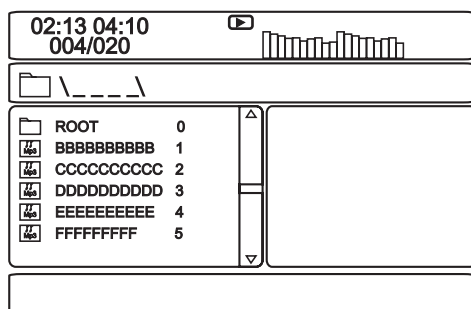

**Figure 44. MENU Screen Display**

When an MP3 disc is inserted into the unit, the menu screen appears automatically. You can use the menu screen to change folders and songs. The system plays the songs in the order they were burned onto the disc.

1. Press the ▲ or ▼ button to choose a folder from the folder list on the left side of the screen.
2. Press ENTER to select the highlighted folder. The songs available under the folder will be listed.
3. Press STOP First, use ▲ or ▼ button to choose a song from the list. Press ENTER to select and begin playback of the highlighted song.

Use the ►► ( NEXT ) button to move to the next song. Press the ◀◀ (PREVIOUS) button to move to the beginning of the previous song.

### **USING THE REPEAT FEATURE**

The default mode for the Repeat feature is OFF. Pressing REPEAT consecutively changes the repeat options:

- SINGLE
- REPEAT ONE
- REPEAT FOLDER
- FOLDER

Pressing REPEAT the 5TH time will resume normal playback. As you toggle through the options, the repeat option changes. The selected repeat option loops repeatedly until you turn it off.

### **NOTE**

- “” icon in front of a file name indicates that this is a folder, not an MP3 file.
- “MP3” icon in front of a file name indicates that this is a MP3 file.

## 6. Playing JPEG file

- 1) Load the JPEG Disc into tray.
- 2) Select JPEG file by pressing "UP/DOWN" button.
- 3) You can preview the JPEG file by pressing "Play" or "ENTER".
- 4) Pressing the "Left Key" will rotate the picture 90 degrees counterclockwise. Pressing the "Right Key" will rotate the picture clockwise.
- 5) When browsing the photos, you can reverse the photo horizontally by pressing "Up" key, or you can reverse the photos vertically by pressing "Down" key.
- 6) When you browse the JPEG file, press "display", there will be different refresh mode below.
  - a. Press "display" first time, "WIPE TOP" will display on the screen, the picture will refresh from top to bottom.
  - b. Press "display" 2nd time, "WIPE BOTTOM" will display on the screen, the picture will refresh from bottom to top.
  - c. Press "display" 3rd time, "WIPE LEFT" will display on the screen, the picture will refresh from left side to right side.
  - d. Press "display" 4th time, "WIPE RIGHT" will display on the screen, the picture will refresh from right side to left side.
  - e. Press "display" 5th time, "DIAGONAL WIPE LEFT TOP" will display on the screen, the picture will refresh from left top to right bottom.
  - f. Press "display" 6th time, "DIAGONAL WIPE RIGHT TOP" will display on the screen, the picture will refresh from right top to left bottom.
  - g. Press "display" 7th time, "DIAGONAL WIPE LEFT BOTTOM" will display on the screen, the picture will refresh from left bottom to right top.
  - h. Press "display" 8th time, "DIAGONAL WIPE RIGHT BOTTOM" will display on the screen, the picture will refresh from right bottom to left top.
  - i. Press "display" 9th time, "EXTEND FROM CENTER H" will display on the screen, the picture will refresh from horizontal center to both sides.
  - j. Press "display" 10th time, "EXTEND FROM CENTER V" will display on the screen, the picture will refresh from vertical center to both sides.

- k. Press “display” 11th time, “COMPRESS TO CENTER H” will display on the screen, the picture will refresh from top and bottom to center.
  - l. Press “display” 12th time, “COMPRESS TO CENTER V” will display on the screen, the picture will refresh from right and left to center.
  - m. Press “display” 13th time, “WINDOW H” will display on the screen, the picture will refresh from four window’s top side to bottom side.
  - n. Press “display” 14th time, “WINDOW V” will display on the screen, the picture will refresh from four window’s left side to right side.
  - o. Press “display” 15th time, “WIPE FROM EDGE TO CENTER” will display on the screen, the picture will refresh from 4 edges to center.
- 7) When previewing the file, pressing “ANGLE, SUBTITLE, AUDIO, NUMBER, AB, RETURN, REW/FF, SLOW” a hand icon will appear on the display meaning that these options are not available.
  - 8) Press “Stop” to browse the JPEG file, “SLIDE SHOW” “MENU” will display on the screen.
  - 9) When browsing the picture, press “Stop” and thumbnail size picture will be displayed. You can select the picture you desire by using the UP/DOWN/LEFT/RIGHT/ENTER key.
  - 10) Press “Play” or “OK”, to preview the left top picture.
  - 11) You can return the root Menu by pressing “left” key.

## 7. Connecting to a TV or another monitor ( Refer to Figure 45)

You can also connect the DVD player to a TV to enjoy high quality stereo sound and picture on another monitor.

1. Connect one end of the audio/video cable's black (1/8" stereo plug) plug into the unit's DVD AUDIO OUT jack, and connect the other end to the AUDIO INPUT jacks on your TV or Monitor (white = left channel, red = right channel).
2. Connect the audio/video cable's yellow plug into the DVD VIDEO OUT jack on the back of the unit, and the other yellow plug to the VIDEO INPUT jack on your TV or Monitor.

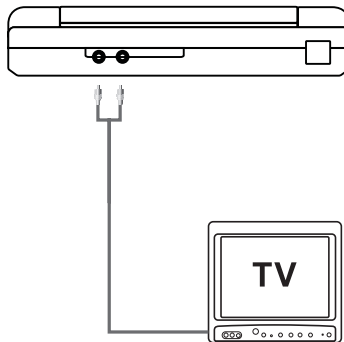

**Figure 45**

## 9. Specifications

Supported Media formats: DVD/CD/MP3

Color system: NTSC

Screen size: 7"

DVD video format: Horizontal 720 pixel, vertical 480 pixel (NTSC)

Frequency response: DVD (PCM 96 kHz/24 bits ): 20 Hz to 44 Hz

DVD (PCM 48 kHz): 20 Hz to 22 kHz

CD: 20 Hz to 20 kHz

Video output: 1.0 Vp-p/75 Ohm, unbalanced

Video S/N: Better than 35 dB

Audio output: 2 x 0.4 W

Audio S/N: Better than 35 dB

Power source: DC 9V

Power consumption: 12 W

Operating temperature: 5~40°C (41~104°F)

Storage temperature: -20~60°C (4~140°F)

Operating humidity: 10~75%

Dimensions (W x H x D):7.87 X 5.92 X1.44inches

200 x 150.5 x 36.5mm

Battery Type: Ni-Mh

\*Specifications subject to change without notice.

## 10. Rechargeable Battery Installation and Use

The player utilizes a set of long-life Ni-Mh batteries for a portable power supply. Ni-MH batteries feature high storage capacity and low level of degradation. This means the Ni-MH batteries do not have "Memory Effect" and thus can be recharged safely regardless of whether the battery is fully or only partially discharged. Please fully charge the battery prior to first use.

**NOTE:** When the DVD player is used with the battery as a power source, ensure that the battery has been charged for at least eight hours prior to connecting it to the DVD player.

If you plan not to use the battery for an extended period of time (one week or longer), we recommend that you first fully charge the battery and store it away properly. For longer periods of storage, please recharge the battery at least once every two months to maintain the



battery in optimum condition. Under no circumstances short the battery terminals, store the battery in a metal container, or leave the battery in a humid or damp environment. Ideally, store the battery in an airtight container with desiccant or other dehumidifying agent. Each full recharge takes approximately five-hours and one full charge can provide power to the player for approximately 3 hours. During recharge, the red indicator will stay on. Once fully recharged, the red light will turn off. At this point you may remove the wall plug and stop charging.

### **Precautions related to Battery Recharge:**

1. Once the battery is fully discharged, immediately recharge (regardless of whether you plan to use battery or not) in order to maximize battery life.
2. To charge the battery, please connect the power jack directly into the DVD player and leave the POWER switch in the off position.

### **Using and Maintaining your Rechargeable Battery**

1. Please make sure you always use **only** the AC adapter included with the player to recharge your batteries.
2. Recharge efficiency will degrade when environmental temperatures drop below 50°F (10°C) or exceed 95°F (35°C).
3. Please remove battery from the player and store it properly if the player is not to be used for long time. During this period, please recharge the battery at least once two months to avoid irreparable damage to the battery.

### Installing the Battery Pack:

1. First, make sure the player is in “Stop” mode and that the AC power supply has been disconnected.
2. Close the player cover.
3. Align the battery pack with the player module’s front edge.
4. Push the battery towards the rear of the player until it locks into position. The lock position is indicated by a click. The unit will fit snugly to the player.
5. Push the battery plug into the DVD player DC input jack.

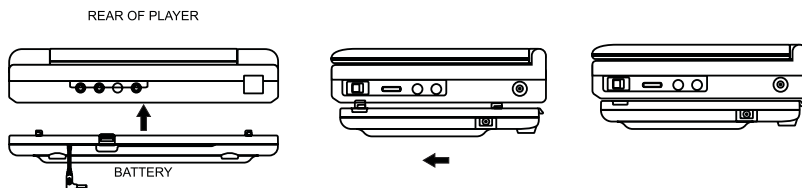

**Figure 46. Installing the DVD Player Battery**

### Removing the Battery Pack:

1. First, make sure the player is in “Stop” mode and the AC power supply has been disconnected.
2. Press the release button on the Rear of battery.
3. Slide the battery towards the Front of the unit.

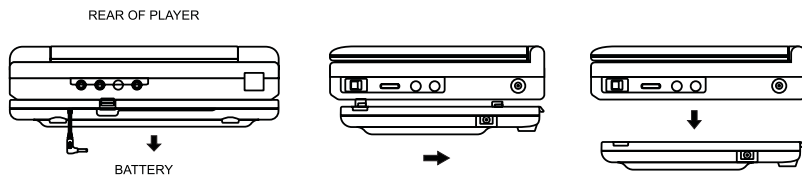

**Figure 47. Removing the DVD Player Battery**

## J. Wired Headphones (Refer to Figure 48)

### 1. WIRED HEADPHONE

Wired headphones may be used with the unit. Simply plug in the headset to either HEADPHONE 1 jack or HEADPHONE 2 jack on the right side of the monitor.

**NOTE:** Plugging into Headphone jack 1 disables the internal speakers.

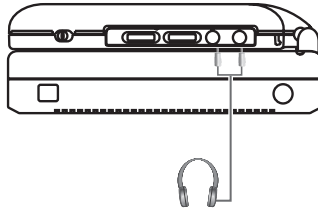

**Figure 48. Wired Headphones**



**AUDIOVOX**  
ELECTRONICS CORP.

## **90 DAY LIMITED WARRANTY**

*Applies to Audiovox Video Products*

AUDIOVOX ELECTRONICS CORP. (the Company) warrants to the original retail purchaser of this product that should this product or any part thereof, under normal use and conditions, be proven defective in material or workmanship within 90 days from the date of original purchase, such defect(s) will be repaired or replaced with reconditioned product (at the Company's option) without charge for parts and repair labor.

To obtain repair or replacement within the terms of this Warranty, the product is to be delivered with proof of warranty coverage (e.g. dated bill of sale), specification of defect(s), transportation prepaid, to the Company at the address shown below.

This Warranty does not extend to the elimination of externally generated static or noise, to correction of antenna problems, to costs incurred for installation, removal or reinstallation of the product, or to damage to tapes, discs, speakers, accessories, or electrical systems.

This Warranty does not apply to any product or part thereof which, in the opinion of the Company, has suffered or been damaged through alteration, improper installation, mishandling, misuse, neglect, accident, or by removal or defacement of the factory serial number/bar code label(s). THE EXTENT OF THE COMPANY'S LIABILITY UNDER THIS WARRANTY IS LIMITED TO THE REPAIR OR REPLACEMENT PROVIDED ABOVE AND, IN NO EVENT, SHALL THE COMPANY'S LIABILITY EXCEED THE PURCHASE PRICE PAID BY PURCHASER FOR THE PRODUCT.

This Warranty is in lieu of all other express warranties or liabilities. ANY IMPLIED WARRANTIES, INCLUDING ANY IMPLIED WARRANTY OF MERCHANTABILITY, SHALL BE LIMITED TO THE DURATION OF THIS WRITTEN WARRANTY. ANY ACTION FOR BREACH OF ANY WARRANTY HEREUNDER INCLUDING ANY IMPLIED WARRANTY OF MERCHANTABILITY MUST BE BROUGHT WITHIN A PERIOD OF 30 MONTHS FROM DATE OF ORIGINAL PURCHASE. IN NO CASE SHALL THE COMPANY BE LIABLE FOR ANY CONSEQUENTIAL OR INCIDENTAL DAMAGES FOR BREACH OF THIS OR ANY OTHER WARRANTY, EXPRESS OR IMPLIED, WHATSOEVER. No person or representative is authorized to assume for the Company any liability other than expressed herein in connection with the sale of this product.

Some states do not allow limitations on how long an implied warranty lasts or the exclusion or limitation of incidental or consequential damage so the above limitations or exclusions may not apply to you. This Warranty gives you specific legal rights and you may also have other rights which vary from state to state.

**U.S.A. :** AUDIOVOX ELECTRONICS CORPORATION, 150 MARCUS BLVD.  
HAUPPAUGE, NEW YORK 11788 • 1-800-645-4994

**CANADA :** CALL 1-800-645-4994 FOR LOCATION OF WARRANTY STATION SERVING YOUR AREA

128-5556C

