

CODE ALARM

PROFESSIONAL SERIES

Security and Keyless Entry Installation Guide

ca 1053

Table of Contents

Before You Begin	3
Wire Connection Guide	4
5 Pin Main Harness	5
6 Pin Input / Output Harness	6
2 Pin Door Lock Output Harness	8
Additional Ports	12
LED Port	12
Programming Port	12
On-Board Shock Sensor	12
Set Up & Programming	13
Transmitter Programming	13
Manual Feature Programming	13
Programming Feature Banks	14
Chirp Delete - User Accessible	15
Dome Light Delay / Theater Dimming	15
Feature Descriptions	16
Transmitter Button Functions	18
Security Trigger Zones	18
System Layout	19

BEFORE YOU BEGIN

PROFESSIONAL INSTALLATION STRONGLY RECOMMENDED

Installation Precautions:



Roll down window to avoid locking keys in vehicle during installation



Avoid mounting components or routing wires near hot surfaces



Avoid mounting components or routing wires near moving parts



Tape or loom wires under hood for protection and appearance



Use grommets when routing wires through metal surfaces



Use a Digital Multi Meter for testing and verifying circuits. **DO NOT USE A TEST LIGHT, OR "COMPUTER SAFE PROBE"** as these can set off air bags or damage vehicle computers.



Technical Support (800) 421-3209
or go to
<http://techservices.codesystems.com>

5 Pin Main Harness

6 PIN MAIN	1	WHITE/RED	PARKING LIGHT INPUT
	2	WHITE	PARKING LIGHT OUTPUT
	3	BLACK	GROUND
	4	BROWN	SIREN / HORN OUTPUT
	5	RED	BATTERY 12V (+)

6 Pin Input / Output Harness

6 PIN INPUT / OUTPUT	1	PURPLE	DOOR TRIGGER INPUT (+)
	2	BLUE	TRUNK PIN INPUT (-)
	3	GREEN	DOOR TRIGGER INPUT (-)
	4	YELLOW	IGNITION INPUT (+)
	5	ORANGE	GROUND WHEN ARMED OUTPUT (-)
	6	RED/WHITE	TRUNK RELEASE OUTPUT (-)

2 Pin Door Lock Output Harness

2 PIN LOCK	1	BLUE	UNLOCK (-)
	2	GREEN	LOCK (-)

5 Pin Main Harness

1	WHITE/RED	PARKING LIGHT INPUT
---	-----------	---------------------

2	WHITE	PARKING LIGHT OUTPUT
---	-------	----------------------

Locate the parking light output wire at the vehicle's light switch.

Verification: This wire registers positive voltage when the parking lights are turned on.

Positive switching Parking Lights:

Connect the WHITE/RED wire to a 15 Amp max fused battery source.

Connect the WHITE wire to the parking light output wire.

Negative switching Parking Lights:

Connect the WHITE/RED wire to a good chassis ground.

Connect the WHITE wire to the parking light output wire.

3	BLACK	GROUND
---	-------	--------

Connect the BLACK wire to a solid chassis ground point using a ring terminal and self tapping screw (not supplied). Scrape away paint from the grounding point to ensure a good connection. The recommended grounding point is a metal surface in the driver's side kick panel area.

NOTE: Do not ground the BLACK wire with any other vehicle components.

4	BROWN	SIREN/HORN OUTPUT
---	-------	-------------------

This output is available to be used as a constant (+) siren output OR a pulsed (-) horn output and is selectable by changing the jumper position on the main module. Refer to the system layout on page 18 for location.

SIREN:

Connect the BLACK siren wire to a chassis ground using a ring terminal and self tapping screw (not supplied).

Route the BROWN siren output wire from the control module through the firewall and connect to the RED wire on the siren.

NOTE: Be sure to loom the siren wires, and seal the grommet.

HORN:

Locate the vehicle's horn wire.

Verification: This wire will register at positive voltage and register ground when the horn switch is pressed.

Connect the BROWN wire to the vehicle's horn wire. This is a low current output, 300mA.

5	RED	BATTERY 12V (+)
---	-----	-------------------

Locate 1 of the vehicle's constant 12 Volt battery wires at the ignition switch.

Verification: This wire will register (+) voltage in all positions of the ignition switch.

Connect the RED wire to the constant 12 Volt battery wire.

NOTE: Remove all fuses until all connections are made.

6 Pin Input / Output Harness

1	PURPLE	DOOR TRIGGER INPUT (+)
---	--------	--------------------------

Locate the vehicle's dome light or door pin switch wire.

Verification: This wire will register positive voltage (POS) when the door is opened and the interior light is on. This wire will register ground or "0" Volts when the door is closed and the interior light is off.

Connect the PURPLE wire to the vehicle's positive door input wire(s).

NOTE: Certain vehicles may require multiple connections. Refer to vehicle application guide

2	BLUE	TRUNK PIN INPUT (-)
---	------	-----------------------

Locate the vehicle's trunk pin switch wire and connect to the BLUE wire.

Verification: This wire when connected will register ground when the vehicle's trunk is opened.

Connect the BLUE wire to the trunk pin.

3 GREEN

DOOR TRIGGER INPUT (-)

Locate the vehicle's dome light or door pin switch wire.

Verification: This wire will register ground (NEG) when the door is opened and the interior light is on. This wire will register positive voltage when the door is closed and the interior light is off.

Connect the GREEN wire to the vehicle's negative door input wire(s).

NOTE: Certain vehicles may require multiple connections. Refer to vehicle application guide

4 YELLOW

IGNITION INPUT (+)

Locate the vehicle's ignition wire at the ignition switch.

Verification: This wire registers voltage when the key is turned to the ON (or RUN) position. The voltage does not drop out when the key is turned to the START (or CRANK) position.

Connect the YELLOW wire to the vehicle's Ignition wire.

5 ORANGE

GROUND WHEN ARMED OUTPUT (-)

This wire will have a continuous (-) 500mA output when the system is Armed. This wire is typically used for controlling window modules or additional sensors.

6 REDWHITE

TRUNK RELEASE OUTPUT (-)

Locate the vehicle's trunk release wire at the trunk release switch.

Verification: This wire will register either positive voltage or ground when the trunk release is activated.

This is a low current output, 200mA.

2 Pin Lock Output Harness

1	BLUE	UNLOCK (-)
---	------	------------

2	GREEN	LOCK (-)
---	-------	----------

The door lock / unlock outputs are designed to control several different types of systems which may require additional parts. Please review the wire and location chart to see which type of door lock system is in your vehicle. The most common types are shown in the following diagrams.

Negative Switching Locks

All Door Lock and Unlock: Locate the lock / unlock wire at the vehicle's lock / unlock switch.

Verification: These wires will register ground when the Lock and Unlock switches are activated.

Connect the GREEN and BLUE wires shown in the diagram below.

Negative Locks:

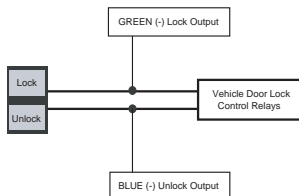

Positive Switching Locks

All Door Lock and Unlock: Locate the lock / unlock wire at the vehicle's lock / unlock switch.

Verification: These wires will register positive voltage when the Lock and Unlock switches are activated.

Connect the GREEN and BLUE wires shown in the diagram below.

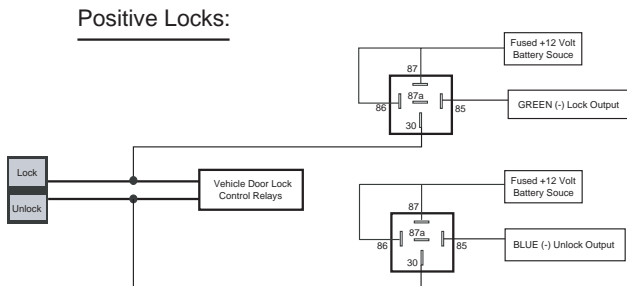

Reverse Polarity Locks (5-Wire Door locks)

All Door Lock and Unlock: Locate the lock / unlock wire at the vehicle's lock / unlock switch.

Verification: These wires will rest at ground and register positive voltage when the Lock and Unlock switches are activated.

Connect the GREEN and BLUE or BLUE/GREEN wires shown in the diagram below using (2) SPDT relays (not supplied).

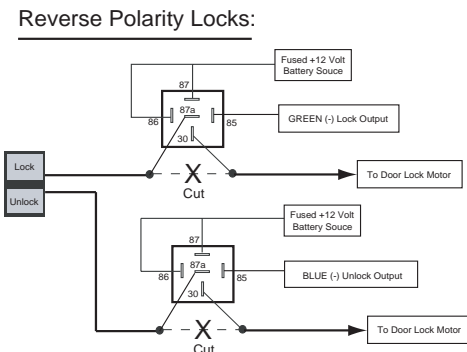

Negative Multiplexed Locks

All Door Lock and Unlock: Locate the lock / unlock wire at the vehicle's lock / unlock switch.

Verification: This wire will show variable ground when the switch is activated. Please consult the wire and location chart for specific resistor values for your vehicle.

Connect the GREEN and BLUE or BLUE/GREEN wires shown in the diagram below using (2) SPDT relays (not supplied).

Multiplex Locks:

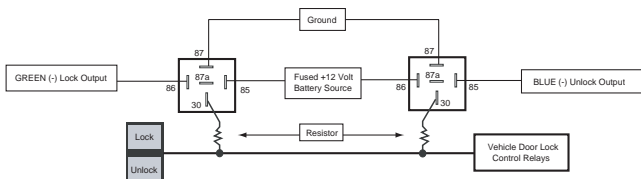

Positive Multiplexed Locks

All Door Lock and Unlock: Locate the lock / unlock wire at the vehicle's lock / unlock switch.

Verification: This wire will show variable positive voltage when the switch is activated. Please consult the wire and location chart for specific resistor values for your vehicle.

Connect the GREEN and BLUE or BLUE/GREEN wires shown in the diagram below using (2) SPDT relays (not supplied).

Multiplex Locks:

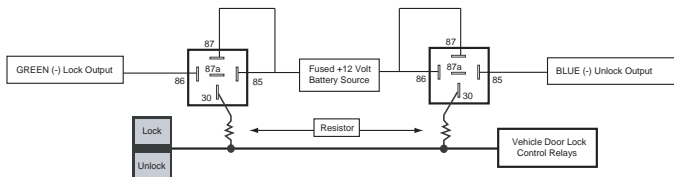

Adding Aftermarket Actuators

After installing aftermarket actuators, (not supplied). Connect the GREEN and BLUE wires shown in the diagram below using (2) SPDT relays (not supplied).

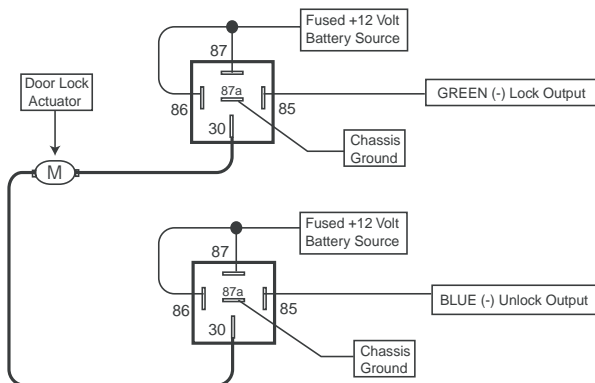

Additional Ports

LED Port

The LED included in the kit will serve as a visual indicator of the alarm's status. It should be installed in the dash, located where it can be easily seen from outside the vehicle, yet not be distracting to the driver. Once a location has been selected, check behind the panel for wire routing access, and to confirm the drill will not damage any existing components as it passes through the panel. Drill a 1/4" hole, and pass the red and blue wires from the LED through the hole, from the front of the panel. Firmly press the body of LED into the hole until fully seated.

Programming / Valet Button Port

Select a mounting location that is within reach of the ignition switch, as this switch in combination with the ignition switch, will be used to program the certain features of the system. It is suggested that the switch be mounted to the lower dash panel in the driver's area within reach of the driver.

On-Board Shock Sensor

Select a solid mounting surface for the alarm module inside the passenger compartment (behind the dash), and mount the sensor using cable ties. Refer to feature programming for on-board shock sensor adjustment.

Data Bus Interface Port

This 4 pin port is used for Flashlogic Door Lock and Transponder Databus Interfaces to communicate with the vehicle's Databus. When using the DBI port to control the Flashlogic Door Lock and Transponder Interface modules the following options may be available. Please refer to the D2D (Data to Data) function list available per vehicle on the tech service web site.

Door Trigger

Trunk/Hatch Open

Door Lock Control

Dome Light Supervision

Factory Alarm Arm / Disarm

Manual Arm / Disarm Inputs (factory keyless controls system)

Set Up & Programming

Transmitter Programming - Feature Bank 1



1. Turn the ignition ON.
2. Press and hold the valet/override button.
3. Within 10 seconds the system will chirp (3) three times.
4. Press 1 button of each transmitter you wish to program.
5. The system will respond with 1 chirp for each accepted transmitter.
6. Pressing the override button at anytime during programming will advance to the next bank.

NOTE: The system will exit transmitter programming after 15 seconds of inactivity.

NOTE: This system has 1 button programming which programs all channels of the system.

NOTE: The system will hold up to 4 transmitters in memory, programming a 5th transmitter will erase the oldest transmitter in memory.

Manual Feature Programming - Feature Bank 2 - 4

1. Turn the ignition ON.
2. Press and hold the valet/override button.
3. Within 10 seconds the system will chirp (3) three times.
4. Use the valet/override button to advance through each option bank. For feature programming advance to Feature Bank 2, 3, or 4 which is (4) four, (5) five or (6) six chirps.
5. Use the transmitter  button to scroll through the selections in each feature bank, the system will chirp to match the feature number.
6. Press the transmitter  button to change the desired feature. The LED will flash indicating the changed feature.

Defaulting All Features: Pressing the  button anytime while in any of the feature banks (except during shock sensor programming) will default all features and return you to feature bank 2 - 4 chirps.

NOTE: The system will remain in feature programming mode as long as the ignition is on, there is no time limit. To exit programming turn the IGNITION OFF.

**Feature Bank 1 - 3 Chirps
Transmitter Programming**

Refer to transmitter programming.

	Feature Bank 2 - 4 Chirps Security Control	1 LED Flash	2 LED Flash	3 LED Flash	4 LED Flash	5 LED Flash
1	Silent Choice	ON	OFF			
2	Passive Locks	Active	Passive			
3	Passive Arming	Active	Passive			
4	N/A	N/A				
5	N/A	N/A				
6	N/A	N/A				
7	Anti-Hijack Mode	OFF	ON			
8	N/A	N/A				
9	DBI Port Protocol	DBI Protocol	ADS Protocol			
10	Arm/Disarm Chirp / Parking Light Pattern	Standard: 2 - Arm 1 - Disarm	Inverted: 1 - Arm 2 - Disarm			

	Feature Bank 3 - 5 Chirps Output Control	1 LED Flash	2 LED Flash	3 LED Flash	4 LED Flash	5 LED Flash
1	Extended Lock Pulse	1 Second	3.5 Seconds	1 Second Lock, Double Pulse Unlock	30 Second Lock, Double Pulse Unlock	Double Pulse Lock, 1 Second Unlock
2	Factory Disarm	N/A				
3	Ignition Controlled Locks	OFF	Lock and Unlock	Lock Only	Unlock Only	









	Feature Bank 4 - 6 Chirps Shock Sensor Adjustment	Increase Sensitivity	Decrease Sensitivity
1	Full Trigger	Press & Release Lock	Press & Release Unlock

Press Lock + Unlock for 2 seconds to lock in the change and move to next setting.

2	Lite Touch	Press & Release Lock	Press & Release Unlock
---	------------	----------------------	------------------------

Press and release Lock + Unlock to lock in the change and exit programming.

Feature Bank 4 - Shock Sensor Adjustment

1. Enter Feature Bank 4
2. Press and release  to select full trigger.
3. Use  or  to adjust the settings. The system will give short chirps upon each press.
4. Press  +  for 2 seconds to lock in the change and advance to the lite touch setting, the system will give 2 long chirps to confirm.
5. Use  or  to adjust the settings.
6. Press and release  +  to lock in the change, the system will exit programming and give 1 long chirp to confirm. **This step must be completed to properly program the shock sensor.**

Chirp Delete - User Accessible

System ARM/DISARM chirps can be toggled ON or OFF without entering the programming feature banks.

1. Turn the ignition ON then OFF.
2. Press and release the valet/programming button 3 times. The system will respond with 1 chirp for ON or 2 chirps for OFF.

Dome Light Delay / Theater Dimming

The system can be programmed to delay arming after the lock button is pressed (60 second max) for vehicles with a dome light delay or theater dimming feature. Once programmed the system will 'learn' the timing of the dome light delay and add 2 seconds before arming.

1. Close all doors with ignition off.
2. Using the transmitter press LOCK, UNLOCK, LOCK, UNLOCK, LOCK, UNLOCK, LOCK. The LED will light solid to indicate the system has entered DOME DELAY LEARN MODE.
3. Immediately OPEN then CLOSE the door WITHOUT disarming the system. The system will then monitor the door trigger wire. Once the dome light turns off, the system will then add 2 seconds and then exit the learning mode.
4. The LED will begin to flash indicating the system has exited the learning mode and is now armed.

Feature Descriptions

Feature Bank 2 - Security

1 - Silent Choice: Controls the normal arm/disarm chirps of the security system.

ON - Silent arming/disarming upon first press of lock/unlock, pressing lock/unlock a second time will activate the arm/disarm chirps respectively. The system will only sound the arm/disarm chirps upon a second press of the lock/unlock buttons.

OFF - normal arm/disarm chirps upon the first press of lock/unlock.

2 - Passive Locks: Determines manual or automatic locking of the vehicle's doors.

Active - Requires use of the transmitter to lock the vehicle's doors.

Passive - Automatically locks the vehicle's doors 1 minute after the last door is closed

3 - Passive Arming: Determines manual or automatic locking of the vehicle's doors.

Active - Requires use of the transmitter to arm the security system.

Passive - Automatically arms the security system 1 minute after the last door is closed

4 - Not available on this model.

5 - Not available on this model.

6 - Not available on this model.

7 - Anti-Hijack Mode: Controls the Car Jack mode - ON / OFF.

OFF - Standard security system operation.

ON - Enables Car Jack mode functionality as described in the owners manual

8 - Not available on this model.

9 - DBI Port Protocol: Determines the protocol type in which the DBI port uses to interface with external modules.

DBI Protocol

ADS Protocol

10 - Arm/Disarm Chirp / Parking Light Pattern: Determines the number of chirps and parking light flashes when the system is armed/disarmed.

Standard - 2 chirps/light flashes with arm, 1 chirp/light flash with disarm.

Inverted - 1 chirp/light flash with arm, 2 chirps/light flashes with disarm.

Feature Bank 3 - Output Control

1 - Extended Lock Pulse: Controls the timing of the BLUE and GREEN lock output wires.

1 Second - Single 1 second lock pulse, single 1 second unlock pulse.

3.5 Seconds - Single 3.5 second lock pulse, single 3.5 second unlock pulse.

1 Second Lock, Double Pulse Unlock - Single 1 second lock pulse, double 1 second unlock pulse.

30 Second Lock, Double Pulse Unlock - Single 30 second lock pulse, double 1 second unlock pulse.

Double Pulse Lock, 1 Second Unlock - Double 1 second lock pulse, single 1 second unlock pulse.

2 - Not available on this model.

3 - Ignition Controlled Locks: Control of door locks when the ignition is cycled ON or OFF.

OFF - Door locks not activated by ignition.

Lock and Unlock - Doors lock when ignition is turned on and unlock when ignition is turned off.

Lock Only - Doors lock when ignition is turned on.

Unlock Only - Doors unlock when ignition is turned off.

Transmitter Button Functions

	Lock	Unlock	Car Find / Panic	Trunk	Operation Method
Lock	X				Press and Release
Unlock		X			Press and Release
Trunk				X	Push and Hold (3 Sec)
Car Finder			X		Press and Release
Panic			X		Push and Hold (3 Sec)
Shock Bypass	X		X		Press and Release Lock then Press Lock + Car Find (within 5 Sec)
Passive Arming Bypass				X	Press 2 Times (within 5 Sec)
Arm with Hidden Alarm Function	X			X	Press Trunk then Lock (within 5 Sec)

Security Trigger Zones

If the security system has been triggered the LED will flash one of the patterns below indicating the zone.

LED FLASHES TRIGGER ZONE

2 Flashes	Hood / Trunk Input
3 Flashes	Door Input
4 Flashes	Shock Sensor
5 Flashes	Ignition Input

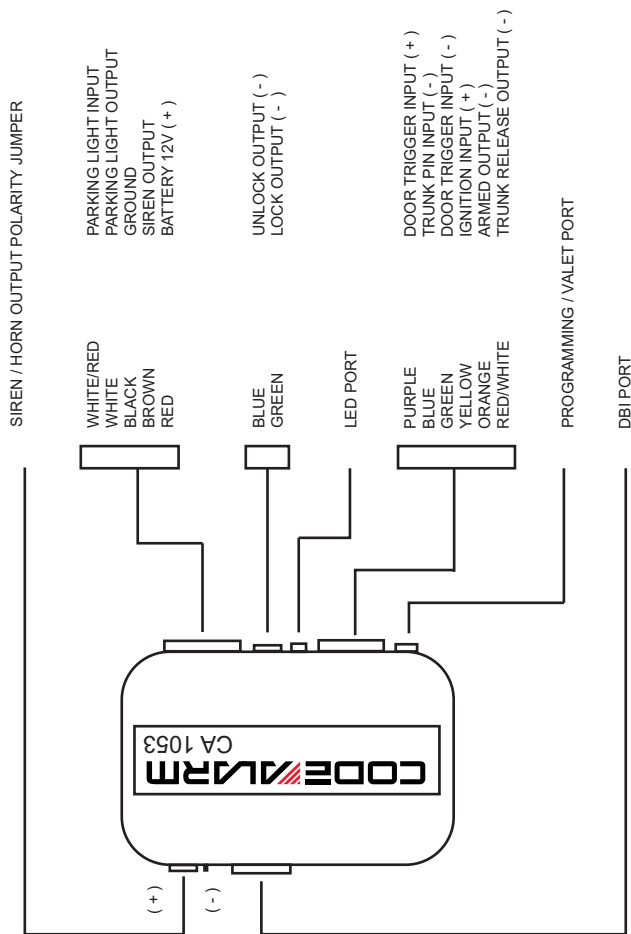

STARTER INTERRUPT RELAY

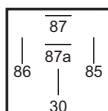

ORANGE
YELLOW
WHITE
RED
OPEN

86 - ARMED OUTPUT (-)
85 - IGNITION (+)
87A - STARTER OUTPUT - MOTOR SIDE
30 - STARTER INPUT - KEY SIDE
87 - OPEN

Audiovox Electronics Corporation.
Customer Service 1-800-421-3209
WWW.CODE-ALARM.COM

FCC COMPLIANCE

This device complies with Part 15 of the FCC rules and with RSS-210 of Industry Canada. Operation is subject to the following two conditions:

1. This device may not cause harmful interference, and
2. This device must accept any interference received, including any interference that may cause undesired operation.

Warning!

Changes or modifications not expressly approved by the party responsible for compliance could void the user's authority to operate the equipment.