

Installation Manual: Mazda CX-5 (2017-2018) Power Lift Gate System

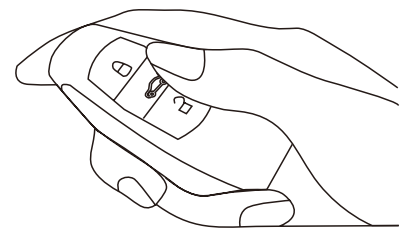
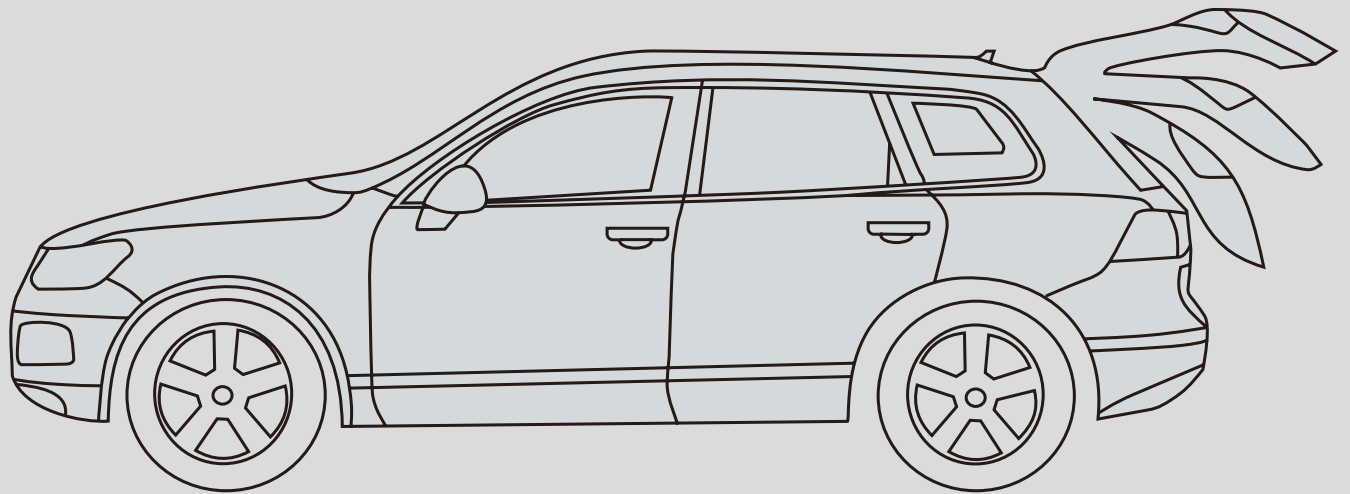

NOTE: Installation Precaution

1. It is recommended to have this product installed by a professional to avoid damage caused by improper installation.
2. Do not attempt to disassemble or modify any components included within the kit. Unapproved modifications or evidence of tampering will void any warranty included with the product.
3. Before installation, inspect the vehicle's controls and interior/exterior for any damage or malfunctioning components. Report any damage or non conformities to the customer prior to installing the product.
4. Inspect the factory lift gate for proper operation and function of lights before installing this product. Improper opening or closing of the lift gate may interfere with the functionality of the Power Lift Gate System.
5. It is recommended to remove or cover any item of clothing (belt buckles, jeans rivets, buttons, etc) prior to installation of this accessory to prevent damage incurred to the vehicle during the installation.
6. Interior panels that have been removed should be set aside somewhere safe during the installation process to avoid damage.
7. When routing and securing wiring harnesses, care should be exercised to avoid any hot, sharp, or moving objects in the vehicle such as steering column, pedals, dash bracing, HVAC components, etc.
8. Do not deviate from methods of installation in this document. Any damage caused by improper wire routing, incorrect connections, wiring, etc. is not covered under the warranty.
9. Disconnect the negative (-) battery terminal before proceeding to installation. Wait at least 2 minutes after disconnecting the negative (-) battery terminal to disable the SRS and other systems in the vehicle. Any damage caused from failure to disconnect the battery is not covered under the warranty.
10. After installation, you must manually close the lift gate to initialize the Power Lift Gate System.

Kit Details

ADVENT

CX5 Liftgate System Layout

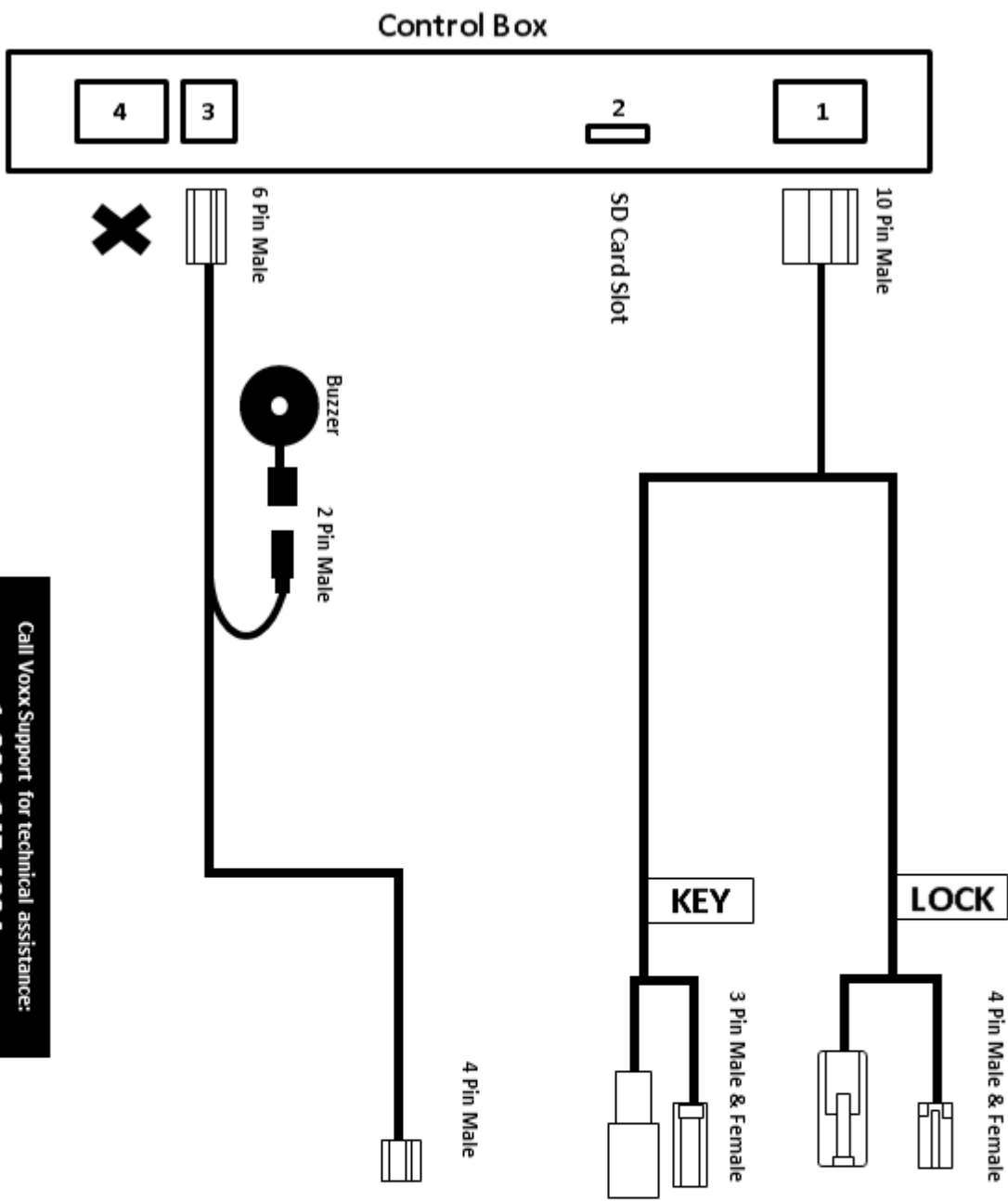

Call Voxx Support for technical assistance:
1-800-645-4994
 9 AM - 6 PM (EST - Eastern) Monday - Friday

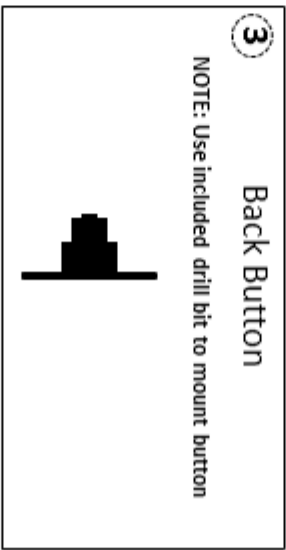
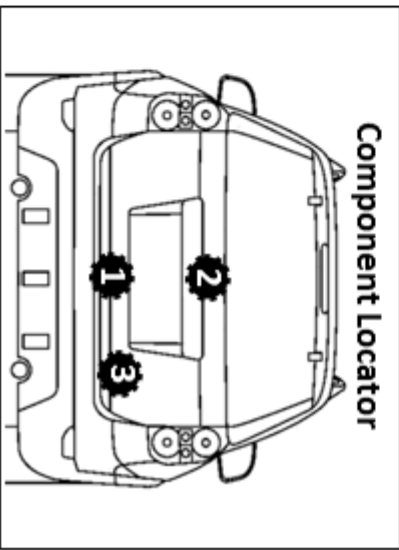

Kit Details

ADVENT CX5 Liftgate System Layout

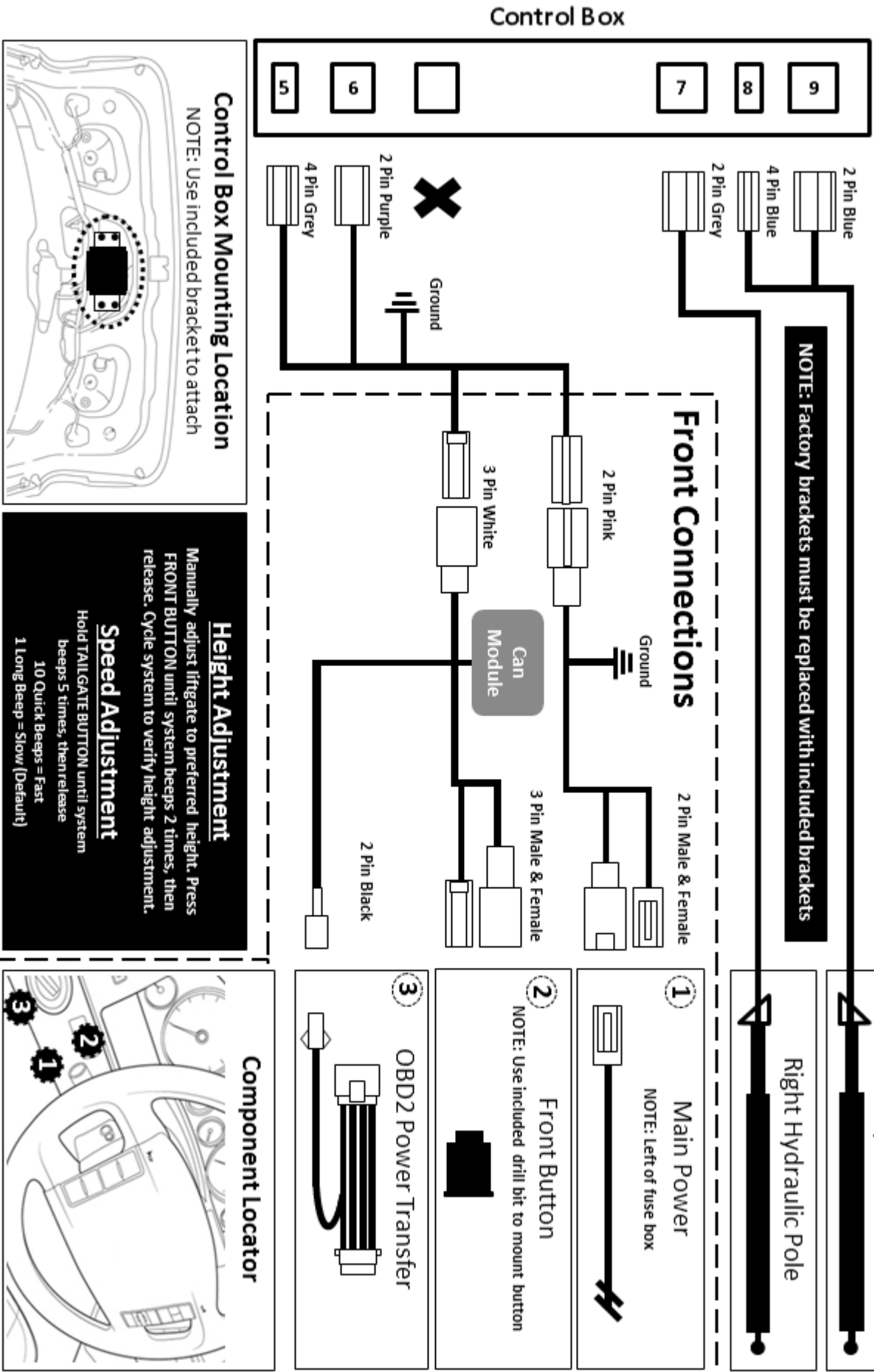

PREPARING FOR INSTALLATION

INSTALLATION PREPARATION

Before starting installation

1. Familiarize yourself with the installation instructions.
2. Inspect kit components to verify everything is present, there is no damage, and to familiarize yourself with the parts.

VEHICLE PREPARATION

1. Place protective coverings on vehicle.
2. Apply protective tape to all points before prying.

3. **"IMPORTANT.....IMPORTANT"**



Disconnect Negative Battery Cable

INSTALLATION:

1. Using a moulding remover, disengage the clips and remove the lift gate pull handle cup.
2. Using a moulding remover, carefully disengage any clips and remove the interior trim panels from the lift gate. Make sure to exercise care and disconnect any electrical connectors to interior lights before pulling too hard, to avoid damage to wiring harnesses.

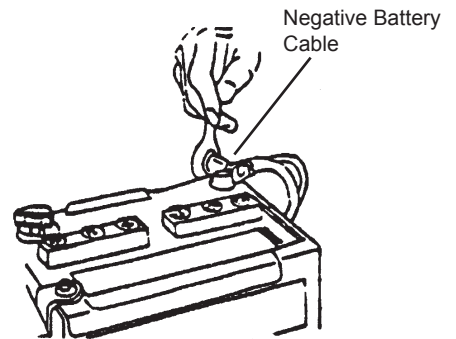

3. Using a helper or supporting brace, support the lift gate in the full opened position.
4. Using a pry tool, remove the clip on the end of the OEM gas support struts for the lift gate.

Exercise caution when removing the support struts, as the lift gate is very heavy once removed.

5. Using a pry tool, remove the clip to disconnect the OEM gas support strut from the OEM body strut mount.

6. Attach the Power Lift Motor to the body mount and the lift gate ball mount, noting the Left and Right designations marked on each Power Lift Motor. Verify the Power Lift Motor is securely attached to both mounts. The end with the wiring harness should be towards the vehicle's body.

Repeat for the opposite side.



7. Remove the factory rubber grommet. Route the wiring harness through the hole and into the lift gate, seating the included grommet on the harness into the cavity from where the factory grommet was removed. Repeat for the opposite side.

NOTE: Limit motor wiring harness slack as much as possible. Extra slack can get caught in weather seal, causing liftgate to leak.

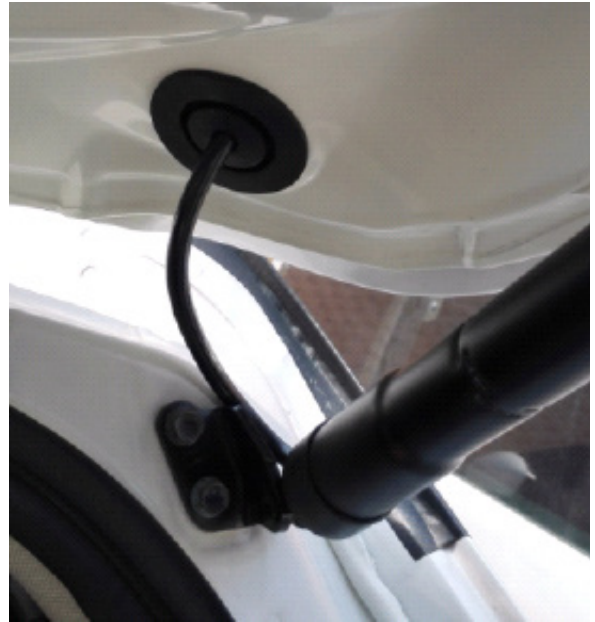

8. Mount the main control module to the lift gate brace using the supplied mounting bracket. Route the Power Lift Motor wire harnesses to the main control module and connect to the corresponding connectors.



9. Locate the OEM outside opener switch connector, on the rear of the switch assembly. Disconnect the OEM connector, and connect our T-Harness in line with the outside opener switch.



10. Locate the OEM power latch. Disconnect the OEM connector, and connect our T-Harness in line with the power latch assembly.



11. Remove the driver's side lower dash panel. Locate the main power wire, and connect in line with the supplied T-Harness.

12. Locate the OBDII connector. Disconnect the connector from its mounting location and connect into the supplied T-Harness. Mount the T-Harness connector into the factory location.

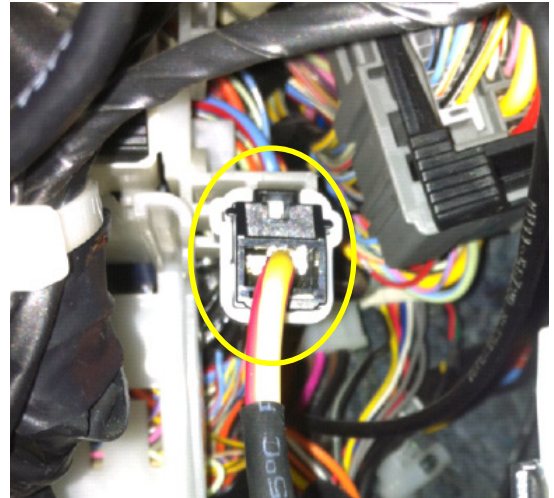

13. Route the main wiring harness along the driver's side floor under the scuff plates to the luggage compartment area.

14. Route the main wiring harness up towards the headliner along the path shown.



15. Route the main wiring harness through the OEM grommet and into the lift gate. Use a fish tape to help in pulling the harness through the factory wiring boot. Exercise care not to damage the harness or connectors when pulling the harness through the boot. Route the main wiring harness along the factory wiring harness to the main control module and connect to the main control module.

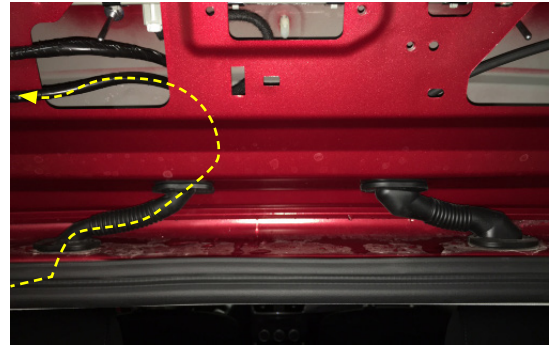

Note: Spraying a small amount of soap/water solution into the OEM wire harness boot will help in pulling the wiring harness through easily.

16. Locate small plaque for rear button placement.



17. Using the supplied drill bit, drill a hole through the center of the small plaque.



18. Remove the original nut from the button. Insert the button through hole drilled in the small-plaque. Install silicon grommet and sandwich plaque between button and grommet. Tighten spring clip until flush with silicon grommet. Verify button is secure.

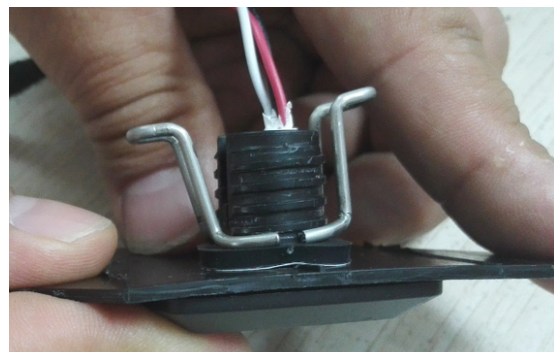

NOTE: Do not reuse original nut from button.

19. Mount the open/close button and secure with the nut. Connect to the main control module.



20. Mount the interior open/close button in the driver's side lower dash panel and secure with the nut. Connect to the wiring harness and reinstall the driver's side lower dash panel.



21. **IMPORTANT:** Prior to closing, ensure door panel is re-installed. Manually close the lift gate to initialize the Power Lift Gate System. Function test the system to verify proper operation.



THESE POINTS MUST BE CHECKED TO ENSURE A QUALITY INSTALLATION

- | | |
|--|--|
| <input type="checkbox"/> Head Light
<i>If the warning lights remains on, it may indicate a system malfunction.</i> | <input type="checkbox"/> Massage Seats (if equipped) |
| <input type="checkbox"/> High Beams | <input type="checkbox"/> Power Side Mirrors (if equipped) |
| <input type="checkbox"/> Turn Signal Lights | <input type="checkbox"/> Side Mirror Defogger (if equipped) |
| <input type="checkbox"/> Tail Lights | <input type="checkbox"/> Front Windshield Defogger (if equipped) |
| <input type="checkbox"/> Stop Lights | <input type="checkbox"/> Navigation System (if equipped) |
| <input type="checkbox"/> Backup Lights | <input type="checkbox"/> Rear Sunshade (if equipped) |
| <input type="checkbox"/> Hazard Lights | <input type="checkbox"/> Cruise Control Light (if equipped) |
| <input type="checkbox"/> Marker Lights | <input type="checkbox"/> Steering Wheel Audio Control (if equipped) |
| <input type="checkbox"/> Dome/Courtesy Lights | <input type="checkbox"/> HVAC |
| <input type="checkbox"/> Panel/Switch Illumination | <input type="checkbox"/> Power Locks (if equipped) |
| <input type="checkbox"/> Accessory Controls/Illumination (if equipped) | <input type="checkbox"/> Power Windows (if equipped) |
| <input type="checkbox"/> Rear Window Defogger (if equipped) | <input type="checkbox"/> Gauges |
| <input type="checkbox"/> Key Sensor Buzzer | <input type="checkbox"/> Front Wiper/Washer |
| <input type="checkbox"/> Fog Lights (if equipped) | <input type="checkbox"/> Hood Latch Release |
| <input type="checkbox"/> Day Time Running Lights (if equipped) | <input type="checkbox"/> Passenger Air Bag Switch (if equipped) |
| <input type="checkbox"/> Trunk/Tailgate/Bed Lights (if equipped) | <input type="checkbox"/> Rollover Side Curtain Air Bag Switch (RSCA) |
| <input type="checkbox"/> Glove Box Light (if equipped) | <input type="checkbox"/> Horn |
| <input type="checkbox"/> ABS Light (if equipped) | <input type="checkbox"/> Seat Belt Warning Light
<i>If the warning lights remains on, it may indicate a system malfunction.</i> |
| <input type="checkbox"/> Rear Wiper/Washer (if equipped) | <input type="checkbox"/> Air Bag Warning Light
<i>If the warning lights remains on, it may indicate a system malfunction.</i> |
| <input type="checkbox"/> Clock (if equipped) | <input type="checkbox"/> Lamp Failure Sensor
<i>If the warning lights remains on, it may indicate a system malfunction.</i> |
| <input type="checkbox"/> Accessory Power Socket (if equipped) | <input type="checkbox"/> Track/Skid Control Light (if equipped)
<i>If the warning lights remains on, it may indicate a system malfunction.</i> |
| <input type="checkbox"/> Starter | <input type="checkbox"/> Tire Pressure Monitoring System (TPMS)
<i>Prior to TPMS activation and Pre-Delivery Service (PDS) of the vehicle the TPMS light will blink when IG is turned on. After TPMS activation and PDS of the vehicle the TPMS light will illuminate for a few seconds and go off when IG is turned on.</i> |
| <input type="checkbox"/> Audio/Video (if equipped) | |
| <input type="checkbox"/> Power Sliding Door (if equipped) | |
| <input type="checkbox"/> Convenience Memory Settings (if equipped) | |
| <input type="checkbox"/> Heated Seats (if equipped) | |